



REPUBLIC OF THE PHILIPPINES
NATIONAL POWER CORPORATION
(Pambansang Korporasyon sa Elektrisidad)

BID DOCUMENTS

Name of Project : **SUPPLY, DELIVERY, INSTALLATION, TESTING AND COMMISSIONING OF HOUSEHOLD ELECTRICAL CONNECTION FOR CAGAYAN AREAS PROJECT**

Project Location : **BABUYAN CLARO, CAGAYAN
DIBAY-DILAM, CAGAYAN
CALAYAN, CAGAYAN
BALATUBAT, CAGAYAN
MINABEL, CAGAYAN**

Specification No. : **LuzP24Z1728Sm**

Contents :

- SECTION I - INVITATION TO BID**
- SECTION II - INSTRUCTIONS TO BIDDERS**
- SECTION III - BID DATA SHEET**
- SECTION IV - GENERAL CONDITIONS OF CONTRACT**
- SECTION V - SPECIAL CONDITIONS OF CONTRACT**
- SECTION VI - TECHNICAL SPECIFICATIONS**
- SECTION VII - BILL OF QUANTITIES**
- SECTION VIII - BIDDING FORMS**
- SECTION IX - BID DRAWINGS**

Design and Development Department



SECTION I

INVITATION TO BID





National Power Corporation

INVITATION TO BID

PUBLIC BIDDING – BCS 2024-0823

- The NATIONAL POWER CORPORATION (NPC), through its approved Corporate Budget of CY 2025 intends to apply the sum of **(Please see schedule below)** being the Approved Budget for the Contract (ABC) to payments under the contract. Bids received in excess of the ABC shall be automatically rejected at Bid opening.

PR Nos./PB Ref No. & Description	Similar Contracts	Pre-bid Conference	Bid Submission / Opening	ABC/ Amt. of Bid Docs
HO-PIB25-002 / PB250121-HB00592 (EPA) Supply, Delivery, Installation, Testing and Commissioning of Household Electrical Connection for Cagayan Areas Project	Supply, Delivery, Installation and Testing of Household Electrical Connection / Electrification Materials	17 December 2024 9:30 A.M.	21 January 2025 9:30 A.M.	₱ 6,295,000.00 / ₱ 10,000.00
S3-WMO25-007 / PB250121-DM00593 (EPA) Supply, Delivery & Testing of Automatic Circuit Recloser	Supply and Delivery of Electrical Components / Equipment for Diesel Power Plant / Substation / Distribution Line / Transmission Line	17 December 2024 9:30 A.M.	21 January 2025 9:30 A.M.	₱ 3,000,000.00 / ₱ 5,000.00
Venue: Kañao Function Room, NPC Bldg. Diliman, Quezon City				

- The NPC now invites bids for Items listed above. Delivery of the Goods is required (see table below) specified in the Technical Specifications. Bidders should have completed, within (see table below) from the date of submission and receipt of bids, a contract similar to the Project. The description of an eligible bidder is contained in the Bidding Documents, particularly, in Section II. (Instruction to Bidders).

PR No/s. / PB Ref No/s.	Delivery Period / Contract Duration	Relevant Period of SLCC reckoned from the date of submission & receipt of bids
HO-PIB25-002	Sixty (60) Calendar Days	Ten (10) Years
S3-WMO25-007	Ninety (90) Calendar Days	Ten (10) Years

- Bidding will be conducted through open competitive bidding procedures using a non-discretionary "pass/fail" criterion as specified in the 2016 revised Implementing Rules and Regulations (IRR) of Republic Act (RA) No. 9184.

Bidding is restricted to Filipino citizens/sole proprietorships, partnerships, or organizations with at least sixty percent (60%) interest or outstanding capital stock belonging to citizens of the Philippines, and to citizens or organizations of a country the laws or regulations of which grant similar rights or privileges to Filipino citizens, pursuant to RA 5183.

- Prospective Bidders may obtain further information from National Power Corporation, Bids and Contracts Services Division and inspect the Bidding Documents at the address given below during office hours (8:00AM to 5:00PM), Monday to Friday.
- A complete set of Bidding Documents may be acquired by interested Bidders from the given address and website(s) and upon payment of the applicable fee for the Bidding Documents, pursuant to the latest Guidelines issued by the GPPB. Bidding fee may be refunded in accordance with the guidelines based on the grounds provided under Section 41 of R.A. 9184 and its Revised IRR.

6. The National Power Corporation will hold a Pre-Bid Conference on the date, time and venue stated above. Interested bidder/s is/are allowed to join and participate in the Pre-Bid Conference at the Kañao Room or virtually. However, those attending virtually shall assume the risk of any internet connectivity issues. Further, interested bidders are hereby informed of the following:
 - a. Only a maximum of two (2) representatives from each bidder / company shall be allowed to participate
 - b. Wearing of Face Masks is recommended but not required in view of Proclamation No. 297 S.2023 lifting the State of Public Health Emergency Throughout the Philippines
 - c. The requirements herein stated including the medium of submission shall be subject to GPPB Resolution No. 09-2020 dated 07 May 2020
 - d. The Guidelines on the Implementation of Early Procurement Activities (EPA) shall be subject to GPPB Circular No. 06-2019 dated 17 July 2019
7. Bids must be duly received by the BAC Secretariat through (i) manual submission at the office address indicated below; (ii) online or electronic submission before the specified time stated in the table above for opening of bids. Late bids shall not be accepted.
8. All Bids must be accompanied by a bid security in any of the acceptable forms and in the amount stated in ITB Clause 14.
9. Bid opening shall be in the Kañao Function Room, NPC Head Office, Diliman, Quezon City and/or via online platform to be announced by NPC. Bids will be opened in the presence of the bidders' representatives who choose to attend the activity.
10. The National Power Corporation reserves the right to reject any and all bids, declare a failure of bidding, or not award the contract at any time prior to contract award in accordance with Sections 35.6 and 41 of the 2016 revised IRR of R.A. No. 9184, without thereby incurring any liability to the affected bidder or bidders.
11. For further information, please refer to:
**Bids and Contracts Services Division,
Logistics Department**
Gabriel Y. Itchon Building
Senator Miriam P. Defensor-Santiago Ave. (formerly BIR Road)
Cor. Quezon Ave., Diliman, Quezon City, 1100
Tel Nos.: Tel Nos.: 8921-3541 local 5564/5713
Email: bcسد@napocor.gov.ph /
12. You may visit the following websites:

For downloading of Bidding Documents: <https://www.napocor.gov.ph/bcsd/bids.php>



ATTY. MELCHOR P. RIDULME
Sr. Vice President & COO and
Chairman, Bids and Awards Committee

SECTION II

INSTRUCTIONS TO BIDDERS



National Power Corporation

**Invitation to Bid for the
SUPPLY, DELIVERY, INSTALLATION, TESTING AND COMMISSIONING OF
HOUSEHOLD ELECTRICAL CONNECTION FOR CAGAYAN AREAS PROJECT
(LuzP24Z1728Sm)**

1. The National Power Corporation (NPC), its CY 2025 Corporate Budget intends to apply the sum stated below, being the Approved Budget for the Contract (ABC) to payments under the contract for the subject PR. Bids received in excess of the ABC shall be automatically rejected at bid opening.

Specs. No./ Description	LuzP24Z1728Sm / SUPPLY, DELIVERY, INSTALLATION, TESTING AND COMMISSIONING OF HOUSEHOLD ELECTRICAL CONNECTION FOR CAGAYAN AREAS PROJECT
ABC	SIX MILLION TWO HUNDRED NINETY FIVE THOUSAND PESOS (₱ 6,295,000.00)

2. The National Power Corporation now invites bids for the above Procurement Project. Delivery of the Goods is required within the contract period specified in the Technical Specifications. Bidders should have completed, within Ten (10) Years from the date of submission and receipt of bids, a contract similar to the Project. The description of an eligible bidder is contained in the Bidding Documents, particularly, in Section II (Instructions to Bidders).
3. Bidding will be conducted through open competitive bidding procedures using a non-discretionary "pass/fail" criterion as specified in the 2016 revised Implementing Rules and Regulations (IRR) of Republic Act (RA) No. 9184.

Bidding is restricted to Filipino citizens/sole proprietorships, partnerships, or organizations with at least sixty percent (60%) interest or outstanding capital stock belonging to citizens of the Philippines, and to citizens or organizations of a country the laws or regulations of which grant similar rights or privileges to Filipino citizens, pursuant to RA 5183.

4. Prospective Bidders may obtain further information from National Power Corporation, Bids and Contracts Services Division and inspect the Bidding Documents at the address given below during office hours (8:00AM to 5:00PM), Monday to Friday.
5. A complete set of Bidding Documents may be acquired by interested Bidders on _____ from the given address and website(s) and upon payment of the applicable fee for the Bidding Documents, pursuant to the latest Guidelines issued by the GPPB, in the amount of **Ten Thousand Pesos (₱ 10,000.00)**.
6. The National Power Corporation will hold a Pre-Bid Conference on _____ at _____ Function Room, NPC H.O., Diliman, Quezon City and/or through video conferencing or webcasting which shall be open to prospective bidders.

7. Bids must be duly received by the BAC Secretariat through (i) manual submission at the office address indicated below; (ii) online or electronic submission as indicated below on or before _____. Late bids shall not be accepted.
8. All Bids must be accompanied by a bid security in any of the acceptable forms and in the amount stated in **ITB** Clause 14.
9. Bid opening shall be on _____, at _____ Function Room, NPC H.O., Diliman, Quezon City and/or via online platform to be announced by NPC. Bids will be opened in the presence of the bidders' representatives who choose to attend the activity.
10. The National Power Corporation reserves the right to reject any and all bids, declare a failure of bidding, or not award the contract at any time prior to contract award in accordance with Sections 35.6 and 41 of the 2016 revised IRR of RA No. 9184, without thereby incurring any liability to the affected bidder or bidders.
11. For further information, please refer to:

BAC SECRETARIAT

Bids & Contracts Services Division
Logistics Department
Gabriel Y. Itchon Building
Sen. Miriam P. Defensor-Santiago Avenue
(formerly BIR Road) cor. Quezon Avenue,
Diliman, Quezon City Philippines 1100
Tel Nos. (02) 8924-5211/(02) 8921-3541 Loc. 5564
www.napocor.gov.ph

12. You may visit the following websites:

For downloading of Bidding Documents: <https://www.napocor.gov.ph>

ATTY. MELCHOR P. RIDULME
Senior Vice President and Chief Operating Officer
Chairman, Bids and Awards Committee

SECTION II – INSTRUCTIONS TO BIDDERS

1. Scope of Bid

The **National Power Corporation (NPC or NAPOCOR)** wishes to receive Bids for the **SUPPLY, DELIVERY, INSTALLATION, TESTING AND COMMISSIONING OF HOUSEHOLD ELECTRICAL CONNECTION FOR CAGAYAN AREAS PROJECT**, with identification number **LuzP24Z1728Sm**.

The Procurement Project (referred to herein as “Project”) is composed of one (1) lot and will be awarded to one (1) Bidder in one complete contract, the details of which are described in Section VI (Technical Specifications).

2. Funding Information

- 2.1. The GOP through the source of funding as indicated below for CY 2025 in the amount of **₱ 6,295,000.00**.
- 2.2. The source of funding is the Corporate Operating Budget of the National Power Corporation.

3. Bidding Requirements

The Bidding for the Project shall be governed by all the provisions of RA No. 9184 and its 2016 revised IRR, including its Generic Procurement Manuals and associated policies, rules and regulations as the primary source thereof, while the herein clauses shall serve as the secondary source thereof.

Any amendments made to the IRR and other GPPB issuances shall be applicable only to the ongoing posting, advertisement, or IB by the BAC through the issuance of a supplemental or bid bulletin.

The Bidder, by the act of submitting its Bid, shall be deemed to have verified and accepted the general requirements of this Project, including other factors that may affect the cost, duration and execution or implementation of the contract, project, or work and examine all instructions, forms, terms, and project requirements in the Bidding Documents.

4. Corrupt, Fraudulent, Collusive, and Coercive Practices

The Procuring Entity, as well as the Bidders and Suppliers, shall observe the highest standard of ethics during the procurement and execution of the contract. They or through an agent shall not engage in corrupt, fraudulent, collusive, coercive, and obstructive practices defined under Annex “I” of the 2016 revised IRR of RA No. 9184 or other integrity violations in competing for the Project.

5. Eligible Bidders

- 5.1. Only Bids of Bidders found to be legally, technically, and financially capable will be evaluated.

- 5.2. Foreign ownership exceeding those allowed under the rules may participate when citizens, corporations, or associations of a country, included in the list issued by the GPPB, the laws or regulations of which grant reciprocal rights or privileges to citizens, corporations, or associations of the Philippines.

The foreign bidder claiming eligibility by reason of their country's extension of reciprocal rights to Filipinos shall submit a certification from the relevant government office of their country stating that Filipinos are allowed to participate in their government procurement activities for the same item/product. The said certification shall be validated during the post-qualification of bidders.

- 5.3. Pursuant to Section 23.4.1.3 of the 2016 revised IRR of RA No.9184, the Bidder shall have an SLCC that is at least one (1) contract similar to the Project the value of which, adjusted to current prices using the PSA's CPI, must be at least equivalent to at least fifty percent (50%) of the ABC.
- 5.4. The Bidders shall comply with the eligibility criteria under Section 23.4.1 of the 2016 IRR of RA No. 9184.

6. Origin of Goods

There is no restriction on the origin of goods other than those prohibited by a decision of the UN Security Council taken under Chapter VII of the Charter of the UN, subject to Domestic Preference requirements under **ITB** Clause 18.

7. Subcontracts

- 7.1. The Bidder may subcontract portions of the Project to the extent allowed by the Procuring Entity as stated herein, but in no case more than twenty percent (20%) of the Project.

The portions of Project and the maximum percentage allowed to be subcontracted are indicated in the **BDS**, which shall not exceed twenty percent (20%) of the contracted Goods.

- 7.2. The Supplier may identify its subcontractor during the contract implementation stage. Subcontractors identified during the bidding may be changed during the implementation of this Contract. Subcontractors must submit the documentary requirements under Section 23.1 of the 2016 revised IRR of RA No. 9184 and comply with the eligibility criteria specified in **ITB** Clause 5 to the implementing or end-user unit.
- 7.3. Subcontracting of any portion of the Project does not relieve the Supplier of any liability or obligation under the Contract. The Supplier will be responsible for the acts, defaults, and negligence of any subcontractor, its agents, servants, or workmen as fully as if these were the Supplier's own acts, defaults, or negligence, or those of its agents, servants, or workmen.

8. Pre-Bid Conference

The Procuring Entity will hold a pre-bid conference for this Project on the specified date and time and either at its physical address and/or through videoconferencing/webcasting as indicated in paragraph 6 of the IB.

9. Clarification and Amendment of Bidding Documents

Prospective bidders may request for clarification on and/or interpretation of any part of the Bidding Documents. Such requests must be in writing and received by the Procuring Entity, either at its given address or through electronic mail indicated in the **IB**, at least ten (10) calendar days before the deadline set for the submission and receipt of Bids.

10. Documents comprising the Bid: Eligibility and Technical Components

- 10.1. The first envelope shall contain the eligibility and technical documents of the Bid as specified in Section VIII (NPCSF-GOODS-01 - Checklist of Technical and Financial Documents).
- 10.2. The Bidder's SLCC as indicated in **ITB** Clause 5.3 should have been completed within Ten (10) Years prior to the deadline for the submission and receipt of bids.
- 10.3. If the eligibility requirements or statements, the bids, and all other documents for submission to the BAC are in foreign language other than English, it must be accompanied by a translation in English, which shall be authenticated by the appropriate Philippine foreign service establishment, post, or the equivalent office having jurisdiction over the foreign bidder's affairs in the Philippines. Similar to the required authentication above, for Contracting Parties to the Apostille Convention, only the translated documents shall be authenticated through an apostille pursuant to GPPB Resolution No. 13-2019 dated 23 May 2019. The English translation shall govern, for purposes of interpretation of the bid.
- 10.4. The Statement of the bidder's Single Largest Completed Contract (SLCC) (NPCSF-GOODS-03) and List of all Ongoing Government & Private Contracts Including Contracts Awarded but not yet Started (NPCSF-GOODS-02) shall comply with the documentary requirements specified in the **BDS**.

11. Documents comprising the Bid: Financial Component

- 11.1. The second bid envelope shall contain the financial documents for the Bid as specified in Section VIII (NPCSF-GOODS-01 - Checklist of Technical and Financial Documents).
- 11.2. If the Bidder claims preference as a Domestic Bidder or Domestic Entity, a certification issued by DTI shall be provided by the Bidder in accordance with Section 43.1.3 of the 2016 revised IRR of RA No. 9184.
- 11.3. Any bid exceeding the ABC indicated in paragraph 1 of the **IB** shall not be accepted.
- 11.4. For Foreign-funded Procurement, a ceiling may be applied to bid prices provided the conditions are met under Section 31.2 of the 2016 revised IRR of RA No. 9184.

12. Bid Prices

- 12.1. Prices indicated on the Price Schedule shall be entered separately in the following manner:
 - a. For Goods offered from within the Procuring Entity's country:

SECTION II – INSTRUCTIONS TO BIDDERS

- i. The price of the Goods quoted EXW (ex-works, ex-factory, ex-warehouse, ex-showroom, or off-the-shelf, as applicable);
 - ii. The cost of all customs duties and sales and other taxes already paid or payable;
 - iii. The cost of transportation, insurance, and other costs incidental to delivery of the Goods to their final destination; and
 - iv. The price of other (incidental) services, if any, listed in the **BDS**.
- b. For Goods offered from abroad:
- i. Unless otherwise stated in the **BDS**, the price of the Goods shall be quoted delivered duty paid (DDP) with the place of destination in the Philippines as specified in the **BDS**. In quoting the price, the Bidder shall be free to use transportation through carriers registered in any eligible country. Similarly, the Bidder may obtain insurance services from any eligible source country.
 - ii. The price of other (incidental) services, if any, as listed in the **BDS**.

13. Bid and Payment Currencies

13.1. For Goods that the Bidder will supply from outside the Philippines, the bid prices may be quoted in the local currency or tradeable currency accepted by the BSP at the discretion of the Bidder. However, for purposes of bid evaluation, Bids denominated in foreign currencies, shall be converted to Philippine currency based on the exchange rate as published in the BSP reference rate bulletin on the day of the bid opening.

13.2. Payment of the contract price shall be made in Philippine Pesos.

14. Bid Security

14.1. The Bidder shall submit a Bid Securing Declaration or any form of Bid Security in the amount indicated in the **BDS**, which shall be not less than the percentage of the ABC in accordance with the schedule in the **BDS**.

14.2. The Bid and bid security shall be valid for **One Hundred Twenty (120) calendar** days from the date of opening of bids. Any Bid not accompanied by an acceptable bid security shall be rejected by the Procuring Entity as non-responsive.

15. Sealing and Marking of Bids

Each Bidder shall submit Two (2) copies of the first and second components of its Bid, marked **Original** and photocopy. Only the original copy will be read and considered for the bid.

Any misplaced document outside of the **Original** copy will not be considered. The photocopy is ONLY FOR REFERENCE.

The Procuring Entity may request additional hard copies and/or electronic copies of the Bid. However, failure of the Bidders to comply with the said request shall not be a ground for disqualification.

If the Procuring Entity allows the submission of bids through online submission to the given website or any other electronic means, the Bidder shall submit an electronic copy of its Bid, which must be digitally signed. An electronic copy that cannot be opened or is corrupted shall be considered non-responsive and, thus, automatically disqualified.

Bidders must also comply with the Disclaimer and Data Privacy Notice specified in the **BDS**.

16. Deadline for Submission of Bids

16.1. The Bidders shall submit on the specified date and time and either at its physical address or through online submission as indicated in paragraph 7 of the **IB**.

17. Opening and Preliminary Examination of Bids

17.1. The BAC shall open the Bids in public at the time, on the date, and at the place specified in paragraph 9 of the **IB**. The Bidders' representatives who are present shall sign a register evidencing their attendance. In case videoconferencing, webcasting or other similar technologies will be used, attendance of participants shall likewise be recorded by the BAC Secretariat.

In case the Bids cannot be opened as scheduled due to justifiable reasons, the rescheduling requirements under Section 29 of the 2016 revised IRR of RA No. 9184 shall prevail.

17.2. The preliminary examination of bids shall be governed by Section 30 of the 2016 revised IRR of RA No. 9184.

18. Domestic Preference

18.1. The Procuring Entity will grant a margin of preference for the purpose of comparison of Bids in accordance with Section 43.1.2 of the 2016 revised IRR of RA No. 9184.

19. Detailed Evaluation and Comparison of Bids

19.1. The Procuring Entity's BAC shall immediately conduct a detailed evaluation of all Bids rated "*passed*," using non-discretionary pass/fail criteria. The BAC shall consider the conditions in the evaluation of Bids under Section 32.2 of the 2016 revised IRR of RA No. 9184.

19.2. If the Project allows partial bids, bidders may submit a proposal on any of the lots or items, and evaluation will be undertaken on a per lot or item basis, as the case maybe. In this case, the Bid Security as required by **ITB** Clause 14 shall be submitted for each lot or item separately.

19.3. The descriptions of the lots or items shall be indicated in **Section VI (Technical Specifications)**, although the ABCs of these lots or items are indicated in the **BDS** for purposes of the NFCC computation pursuant to Section 23.4.2.6 of the

2016 revised IRR of RA No. 9184. The NFCC must be sufficient for the total of the ABCs for all the lots or items participated in by the prospective Bidder.

- 19.4. The Project shall be awarded to one (1) Bidder in one complete contract.
- 19.5. Except for bidders submitting a committed Line of Credit from a Universal or Commercial Bank in lieu of its NFCC computation, all Bids must include the NFCC computation pursuant to Section 23.4.1.4 of the 2016 revised IRR of RA No. 9184, which must be sufficient for the total of the ABCs for all the lots or items participated in by the prospective Bidder. For bidders submitting the committed Line of Credit, it must be at least equal to ten percent (10%) of the ABCs for all the lots or items participated in by the prospective Bidder.

20. Post-Qualification

- 20.1. Within a non-extendible period of five (5) calendar days from receipt by the Bidder of the notice from the BAC that it submitted the Lowest Calculated Bid, the Bidder shall submit its latest income and business tax returns filed and paid through the BIR Electronic Filing and Payment System (eFPS) and other appropriate licenses and permits required by law and stated in the **BDS**.

21. Signing of the Contract

- 21.1. The documents required in Section 37.2 of the 2016 revised IRR of RA No. 9184 shall form part of the Contract. Additional Contract documents are indicated in the **BDS**.

SECTION III

BID DATA SHEET

SECTION III - BID DATA SHEET

ITB Clause	
5.3	<p>For this purpose, similar contracts shall refer to supply, delivery, installation and testing of household connection/electrification materials.</p> <p>The Single Largest Completed Contract (SLCC) as declared by the bidder shall be verified and validated to ascertain such completed contract. Hence, bidders must ensure access to sites of such projects/equipment to NPC representatives for verification and validation purposes during post-qualification process.</p> <p>It shall be a ground for disqualification, if verification and validation cannot be conducted for reasons attributable to the Bidder.</p>
7.1	<p>Subcontracting may be allowed on transport, local/non-skilled labor under the supervision of the Bidder. The Bidder shall not be relieved from any liability or obligation that may arise from the performance of the Subcontractor.</p>
10.1	<p>The prospective bidder shall submit a valid and updated Certificate of PhilGEPs Registration under Platinum Membership (all pages including the Annex A of the said Certificate). Non-compliance shall be a ground for disqualification.</p>
10.4	<p>The list of on-going contracts (Form No. NPCSF-GOODS-02) shall be supported by the following documents for each on-going contract to be submitted during Post-Qualification:</p> <ol style="list-style-type: none"> 1. Contract/Purchase Order and/or Notice of Award 2. Certification coming from the project owner/client that the performance is satisfactory as of the bidding date <p>The bidder shall declare in this form all his on-going government and private contracts including contracts where the bidder (either as individual or as a Joint Venture) is a partner in a Joint Venture agreement other than his current joint venture where he is a partner. Non declaration will be a ground for disqualification of bid.</p> <p>The Statement of the bidder's Single Largest Completed Contract (SLCC) similar to the contract to be bid (Form No. NPCSF-GOODS-03) shall be supported by the following documents to be submitted during Bid Opening:</p> <ol style="list-style-type: none"> 1. Certificate of Acceptance; or Certificate of Completion; or Official Receipt (O.R); or Sales Invoice <p>Any single bidder/s who already procured/secured the bidding documents but want to avail the Joint Venture Agreement (JVA) shall inform the BAC in writing prior to the bid opening for records and documentation purposes.</p>

<p>10.5</p>	<p>Bidders shall also submit the following requirements in their first envelope, Eligibility and Technical Component of their bid:</p> <ol style="list-style-type: none"> 1. Duly signed and completely filled-out Technical Data Sheets (Section VI – Part II TDS) <p>Manufacturer’s brochures, manuals and other supporting documents of equipment, materials, hardware and tools proposed by the bidders must comply with the technical specifications of such equipment, materials, hardware and tools. It shall be a ground for disqualification if the submitted brochures, manuals and other supporting documents are determined not complying with the specifications during technical evaluation and post-qualification process.</p> <p>Equipment, materials, hardware and tools proposed by the winning bidder to be supplied, which were evaluated to be complying with the technical specifications, shall not be replaced and must be the same items to be delivered/installed/used during the contract implementation. Any proposed changes/replacement of said items may be allowed on meritorious reasons subject to validation and prior approval by NPC.</p> <ol style="list-style-type: none"> 2. Complete eligibility documents of the proposed sub-contractor, if any
<p>12</p>	<p>The price of the Goods shall be quoted DDP Project Site or the applicable International Commercial Terms (INCOTERMS) for this Project.</p>
<p>14.1</p>	<p>The bid security shall be in the form of a Bid Securing Declaration, or any of the following forms and amounts:</p> <ol style="list-style-type: none"> a) The amount of not less two percent (2%) of ABC, if bid security is in cash, cashier’s/manager’s check, bank draft/guarantee or irrevocable letter of credit; or b) The amount of not less than five percent (5%) of ABC, if bid security is in Surety Bond.
<p>15.0</p>	<p>All bid submissions and related correspondences are confidential and for viewing only by the intended recipient/s. Any unauthorized access to review, reproduce, or disseminate the information contained therein is strictly prohibited. The National Power Corporation (NAPOCOR) does not guarantee the security of any information electronically transmitted.</p> <p>Bid submissions and related correspondences may contain personal and sensitive personal information, and are subject to the Data Privacy Act of 2012, its implementing rules, regulations and issuances of the National Privacy Commission of the Philippines (“Privacy Laws”). By viewing, using, storing, sharing and disposing (collectively “Processing”), such bids submissions and correspondences, you agree to comply with the Privacy Laws. By responding to correspondence, you consent to the Processing by NAPOCOR of the Personal Data contained in your submission/reply in accordance with NAPOCOR’s Personal Data Privacy Policy which you can find at http://www.napocor.gov.ph.</p> <p>To report any privacy issue, contact the Data Privacy Officer at dpo@napocor.gov.ph.</p>



SECTION III – BID DATA SHEET

	NAPOCOR is not liable for the proper and complete transmission of the information contained in bid submission/correspondences nor for any delay in its receipt.
19.3	<p>The Goods are grouped together in one (1) lot and will be awarded to one (1) Bidder in one complete contract.</p> <p>Partial bid is not allowed. The Goods are grouped in a single lot and the lot shall not be divided into sub-lots for the purpose of bidding, evaluation, and contract award.</p> <p>The Bidders bid offer must be within the ABC of the lot.</p> <p>Bid offers that exceed the ABC of the lot or with incomplete price, shall be rejected.</p>
19.5	If the Bidder opted to submit a Committed Line of Credit (CLC), the bidder must submit a granted credit line valid/effective at the date of bidding.
20.1	<p>Additional documents to be submitted during Post-Qualification:</p> <ol style="list-style-type: none"> Class A – Eligibility Documents listed on the Annex A of Certificate of PhilGEPs Registration under Platinum Membership pursuant to Section 34.3 of the Revised IRR of R.A. 9184 Contract/Purchase Order and/or Notice of Award for the contracts stated in the List of all Ongoing Government & Private Contracts Including Contracts Awarded but not yet Started (NPCSF-GOODS-02); Certification coming from the project owner/client that the performance is satisfactory as of the bidding date for all ongoing contracts stated in Form NPCSF-GOODS-02; Contract/Purchase Order for the contract stated in the Statement of the bidder's Single Largest Completed Contract (SLCC) similar to the contract to be bid (Form No. NPCSF-GOODS-03)
20.2	The licenses and permits relevant to the Project and the corresponding law requiring it as specified in the Technical Specifications, if any.
21.2	Notice to Proceed.

SECTION IV

GENERAL CONDITIONS OF CONTRACT

SECTION IV – GENERAL CONDITIONS OF CONTRACT

TABLE OF CONTENTS

Clause No.	Title	Page no.
1.	SCOPE OF CONTRACT	1
2.	ADVANCE PAYMENT AND TERMS OF PAYMENT	1
3.	PERFORMANCE SECURITY	1
4.	INSPECTION AND TESTS	1
5.	WARRANTY	2
6.	LIABILITY OF THE SUPPLIER	2



SECTION IV – GENERAL CONDITIONS OF CONTRACT

1. Scope of Contract

This Contract shall include all such items, although not specifically mentioned, that can be reasonably inferred as being required for its completion as if such items were expressly mentioned herein. All the provisions of RA No. 9184 and its 2016 revised IRR, including the Generic Procurement Manual, and associated issuances, constitute the primary source for the terms and conditions of the Contract, and thus, applicable in contract implementation. Herein clauses shall serve as the secondary source for the terms and conditions of the Contract.

This is without prejudice to Sections 74.1 and 74.2 of the 2016 revised IRR of RA No. 9184 allowing the GPPB to amend the IRR, which shall be applied to all procurement activities, the advertisement, posting, or invitation of which were issued after the effectivity of the said amendment.

Additional requirements for the completion of this Contract shall be provided in the **Special Conditions of Contract (SCC)**.

2. Advance Payment and Terms of Payment

2.1. Advance payment of the contract amount is provided under Annex "D" of the revised 2016 IRR of RA No. 9184.

2.2. The Procuring Entity is allowed to determine the terms of payment on the partial or staggered delivery of the Goods procured, provided such partial payment shall correspond to the value of the goods delivered and accepted in accordance with prevailing accounting and auditing rules and regulations. The terms of payment are indicated in the **SCC**.

3. Performance Security

3.1. Within ten (10) calendar days from receipt of the Notice of Award by the Bidder from the Procuring Entity but in no case later than the signing of the Contract by both parties, the successful Bidder shall furnish the performance security in any of the forms prescribed in Section 39 of the 2016 revised IRR of RA No. 9184.

3.2. The performance bond to be posted by the Contractor must also comply with additional requirements specified in the **SCC**.

4. Inspection and Tests

The Procuring Entity or its representative shall have the right to inspect and/or to test the Goods to confirm their conformity to the Project specifications at no extra cost to the Procuring Entity in accordance with the Generic Procurement Manual. In addition to tests in the **SCC, Section VI (Technical Specifications)** shall specify what inspections and/or tests the Procuring Entity requires, and where they are to be

conducted. The Procuring Entity shall notify the Supplier in writing, in a timely manner, of the identity of any representatives retained for these purposes.

All reasonable facilities and assistance for the inspection and testing of Goods, including access to drawings and production data, shall be provided by the Supplier to the authorized inspectors at no charge to the Procuring Entity.

5. Warranty

5.1 In order to assure that manufacturing defects shall be corrected by the Supplier, a warranty shall be required from the Supplier as provided under Section 62.1 of the 2016 revised IRR of RA No. 9184.

5.2 The Procuring Entity shall promptly notify the Supplier in writing of any claims arising under this warranty. Upon receipt of such notice, the Supplier shall correct/repair or replace the defective Goods or parts thereof within the period specified in the SCC, without cost to the Procuring Entity, pursuant to the Generic Procurement Manual.

6. Liability of the Supplier

The Supplier's liability under this Contract shall be as provided by the laws of the Republic of the Philippines.

If the Supplier is a joint venture, all partners to the joint venture shall be jointly and severally liable to the Procuring Entity.

SECTION V

SPECIAL CONDITIONS OF CONTRACT

SECTION V – SPECIAL CONDITIONS OF CONTRACT

GCC Clause	
1	<p>Delivery and Documents –</p> <p>The delivery terms applicable to the Contract is DDP delivered to the project site specified in the technical specifications, in accordance with INCOTERMS. Risk and title will pass from the Supplier to the Procuring Entity upon receipt and final acceptance of the Goods at their final destination.</p> <p>Delivery of the Goods shall be made by the Supplier in accordance with the terms specified in Section VI – Technical Specifications. The details of shipping and/or other documents to be furnished by the Supplier are as follows:</p> <p><i>For Goods supplied from within the Philippines</i></p> <p>Upon delivery of the Goods to the Project Site, the Supplier shall notify the Procuring Entity and present the following documents to the Procuring Entity:</p> <ul style="list-style-type: none"> (i) Original and four copies of the Supplier’s invoice showing Goods’ description, quantity, unit price, and total amount; (ii) Original and four copies of Supplier’s factory test/inspection report; (iii) Original and four copies of the certificate of origin (for imported Goods); (iv) Delivery receipt detailing number and description of items received signed by the Procuring Entity’s representative at the Project Site; (v) Certificate of Completion/Inspection Report signed by the Procuring Entity’s representative at the Project Site; (vi) Original and four copies of the Inspection Receiving Report signed by the Procuring Entity’s representative at the Project Site; (vii) Original and four copies of the Manufacturer’s and/or Supplier’s warranty certificate; and (viii) Documents specified in the Technical Specifications, if any. <p><i>For Goods supplied from abroad:</i></p> <p>Upon shipment, the Supplier shall notify the Procuring Entity and the insurance company by e-mail the full details of the shipment, including Contract Number, description of the Goods, quantity, vessel, bill of lading number and date, port of loading, date of shipment, port of discharge etc. Upon delivery to the Project Site, the Supplier shall notify the Procuring Entity and present the following documents as applicable with the documentary requirements of any letter of credit issued taking precedence:</p>



- (i) Original and four copies of the Supplier's invoice showing Goods' description, quantity, unit price, and total amount;
- (ii) Original and four copies of the negotiable, clean shipped on board bill of lading marked "freight pre-paid" and five copies of the non-negotiable bill of lading ;
- (iii) Original and four copies of Supplier's factory test/inspection report;
- (iv) Delivery receipt detailing number and description of items received signed by the Procuring Entity's representative at the Project Site;
- (v) Certificate of Completion/Inspection Report signed by the Procuring Entity's representative at the Project Site;
- (vi) Original and four copies of the Inspection Receiving Report signed by the Procuring Entity's representative at the Project Site;
- (vii) Original and four copies of the certificate of origin (for imported Goods); and
- (viii) Original and four copies of the Manufacturer's and/or Supplier's warranty certificate including all other documents specified in the Technical Specifications, if any.

For purposes of this Clause the Procuring Entity's Representative at the Project Site is the Vice President - SPUG or duly authorized representative..

Incidental Services –

The Supplier is required to provide all of the following services, including additional services, if any, specified in Section VII - Schedule of Requirements:

- a. performance or supervision of on-site assembly and/or start-up of the supplied Goods;
- b. furnishing of tools required for assembly and/or maintenance of the supplied Goods;
- c. furnishing of a detailed operations and maintenance manual for each appropriate unit of the supplied Goods;
- d. performance or supervision or maintenance and/or repair of the supplied Goods, for a period of time agreed by the parties, provided that this service shall not relieve the Supplier of any warranty obligations under this Contract; and
- e. training of the Procuring Entity's personnel, at the Supplier's plant and/or on-site, in assembly, start-up, operation, maintenance, and/or repair of the supplied Goods.

- f. Additional requirements specified in Section VI - Technical Specifications, if any.

The Contract price for the Goods shall include the prices charged by the Supplier for incidental services and shall not exceed the prevailing rates charged to other parties by the Supplier for similar services.

Spare Parts -

The Supplier is required to provide all of the following materials, notifications, and information pertaining to spare parts manufactured or distributed by the Supplier:

1. such spare parts as the Procuring Entity may elect to purchase from the Supplier, provided that this election shall not relieve the Supplier of any warranty obligations under this Contract; and
2. in the event of termination of production of the spare parts:
 - i. advance notification to the Procuring Entity of the pending termination, in sufficient time to permit the Procuring Entity to procure needed requirements; and
 - ii. following such termination, furnishing at no cost to the Procuring Entity, the blueprints, drawings, and specifications of the spare parts, if requested

The spare parts and other components required are listed in **Section VI (Technical Specifications)** and **Section VII (Schedule of Requirements/Bid Price Schedule)** and the costs thereof are included in the contract price.

The Supplier shall carry sufficient inventories to assure ex-stock supply of consumable spare parts or components for the Goods for the period specified in the Technical Specifications.

Spare parts or components shall be supplied as promptly as possible, but in any case, within three (3) months of placing the order.

Packaging -

The Supplier shall provide such packaging of the Goods as is required to prevent their damage or deterioration during transit to their final destination, as indicated in this Contract. The packaging shall be sufficient to withstand, without limitation, rough handling during transit and exposure to extreme temperatures, salt and precipitation during transit, and open storage. Packaging case size and weights shall take into consideration, where appropriate, the remoteness of the Goods' final destination and the absence of heavy handling facilities at all points in transit.

The packaging, marking, and documentation within and outside the packages shall comply strictly with such special requirements as shall be expressly provided for in the Contract, including additional requirements, if any, specified below, and in any subsequent instructions ordered by the Procuring Entity.

The outer packaging must be clearly marked on at least four (4) sides as follows:

Name of the Procuring Entity
Name of the Supplier
Contract Description
Final Destination
Gross weight
Any special lifting instructions
Any special handling instructions
Any relevant HAZCHEM classifications

A packaging list identifying the contents and quantities of the package is to be placed on an accessible point of the outer packaging if practical. If not practical the packaging list is to be placed inside the outer packaging but outside the secondary packaging.

Transportation –

Where the Supplier is required under Contract to deliver the Goods CIF, CIP, or DDP, transport of the Goods to the port of destination or such other named place of destination in the Philippines, as shall be specified in this Contract, shall be arranged and paid for by the Supplier, and the cost thereof shall be included in the Contract Price.

Where the Supplier is required under this Contract to transport the Goods to a specified place of destination within the Philippines, defined as the Project Site, transport to such place of destination in the Philippines, including insurance and storage, as shall be specified in this Contract, shall be arranged by the Supplier, and related costs shall be included in the contract price.

Where the Supplier is required under Contract to deliver the Goods CIF, CIP or DDP, Goods are to be transported on carriers of Philippine registry. In the event that no carrier of Philippine registry is available, Goods may be shipped by a carrier which is not of Philippine registry provided that the Supplier obtains and presents to the Procuring Entity certification to this effect from the nearest Philippine consulate to the port of dispatch. In the event that carriers of Philippine registry are available but their schedule delays the Supplier in its performance of this Contract the period from when the Goods were first ready for shipment and the actual date of shipment the period of delay will be considered force majeure.

The Procuring Entity accepts no liability for the damage of Goods during transit other than those prescribed by INCOTERMS for DDP deliveries. In the case of Goods supplied from within the Philippines or supplied by domestic Suppliers risk and title will not be deemed to have passed to the Procuring Entity until their receipt and final acceptance at the final destination.

Intellectual Property Rights –

The Supplier shall indemnify the Procuring Entity against all third-party claims of infringement of patent, trademark, or industrial design rights arising from use of the Goods or any part thereof.

2.2	<p>Advance payment not to exceed fifteen percent (15%) of the contract amount shall be allowed and paid within sixty (60) calendar days from effectivity of the contract and upon the submission to and acceptance by the Procuring Entity of an irrevocable letter of credit or bank guarantee issued by a Universal or Commercial Bank. The irrevocable letter of credit or bank guarantee must be for an equivalent amount, shall remain valid until the goods are delivered, and accompanied by a claim for advance payment.</p> <p>All progress payments shall first be charged against the advance payment until the latter has been fully exhausted.</p> <p>The terms of payment shall be as follows:</p> <p>1) For Supply and Delivery Contracts:</p> <p>(a) On Contract Effectivity: Advance payment of Fifteen percent (15%) of the total Contract Price shall be paid within sixty (60) days from effectivity of the Contract and upon submission of a claim and an irrevocable letter of credit or bank guarantee issued by a Universal or Commercial Bank for the equivalent amount valid until the Goods are delivered and in the form provided in Section VIII- Bidding Forms.</p> <p>(b) On Delivery: Eighty percent (80%) of the Contract Price of the delivered Goods shall be considered for payment, less the total amount of advance payment, if any and other deductions. If the amount is sufficient to fully recoup the advance payment, the remainder after deductions shall be paid to the Supplier within sixty (60) days after the date of receipt of the Goods and upon submission of the documents (i) through (vi) specified in the <u>SCC</u> provision on Delivery and Documents. Otherwise, the total delivery payment shall be charged against the advance payment and the remaining advance payment will be fully recouped from the succeeding claims.</p> <p>(c) On Acceptance: The remaining twenty percent (20%) of the Contract Price of the delivered Goods shall be paid to the Supplier within sixty (60) days after the date of submission of the acceptance and inspection certificate for the respective delivery issued by the Procuring Entity's authorized representative. In the event that no acceptance certificate is issued by the Procuring Entity's authorized representative within forty five (45) days after successful test and commissioning, if required, the Supplier shall have the right to claim payment of the remaining twenty percent (20%) subject to the Procuring Entity's own verification of the reason(s) for the failure to issue documents (vii) and (viii) as described in the <u>SCC</u> provision on Delivery and Documents.</p> <p>2) For Supply, Delivery, Installation, Test and Commissioning Contracts:</p> <p>(a) On Contract Effectivity: Advance payment of Fifteen percent (15%) of the total Contract Price shall be paid within sixty (60) days from effectivity of the Contract and upon submission of a claim and an irrevocable letter of credit or bank guarantee issued by a Universal or</p>
-----	---

Commercial Bank for the equivalent amount valid until the Goods are delivered and in the form provided in Section VIII- Bidding Forms.

(b) On Delivery: Eighty percent (80%) of the price of the **delivered Goods**, excluding price for installation, test and commissioning shall be considered for payment, less the total amount of advance payment, if any and other deductions. If the amount is sufficient to fully recoup the advance payment, the remainder after deductions shall be paid to the Supplier within sixty (60) days after the date of receipt of the Goods and upon submission of the documents (i) through (vi) specified in the SCC provision on Delivery and Documents. Otherwise, the total delivery payment shall be charged against the advance payment and the remaining advance payment will be fully recouped from the succeeding claims.

(c) On Acceptance: The remaining twenty percent (20%) of the price of the **delivered Goods** plus price for installation, test and commissioning shall be paid to the Supplier within sixty (60) days after the date of submission of the acceptance and inspection certificate for the respective delivery issued by the Procuring Entity's authorized representative. In the event that no acceptance certificate is issued by the Procuring Entity's authorized representative within forty five (45) days after successful test and commissioning, the Supplier shall have the right to claim payment subject to the Procuring Entity's own verification of the reason(s) for the failure to issue documents (vii) and (viii) as described in the SCC provision on Delivery and Documents.

3) For Supply, Delivery, Installation, Test and Commissioning Contracts where Installation, Test and Commissioning prices are included in the supply price:

(a) On Contract Effectivity: Advance payment of Fifteen percent (15%) of the total Contract Price shall be paid within sixty (60) days from effectivity of the Contract and upon submission of a claim and an irrevocable letter of credit or bank guarantee issued by a Universal or Commercial Bank for the equivalent amount valid until the Goods are delivered and in the form provided in Section VIII- Bidding Forms.

(b) On Delivery: Sixty percent (60%) of the price of the **delivered Goods** shall be considered for payment, less the total amount of advance payment, if any and other deductions. If the amount is sufficient to fully recoup the advance payment, the remainder after deductions shall be paid to the Supplier within sixty (60) days after the date of receipt of the Goods and upon submission of the documents (i) through (vi) specified in the SCC provision on Delivery and Documents. Otherwise, the total delivery payment shall be charged against the advance payment and the remaining advance payment will be fully recouped from the succeeding claims.

(c) On Acceptance: The remaining forty percent (40%) of the price of the **delivered Goods** shall be paid to the Supplier within sixty (60) days after the date of submission of the acceptance and inspection certificate for the respective delivery issued by the Procuring Entity's

SECTION V – SPECIAL CONDITIONS OF CONTRACT

	<p>authorized representative. In the event that no acceptance certificate is issued by the Procuring Entity's authorized representative within forty five (45) days after successful test and commissioning, the Supplier shall have the right to claim payment subject to the Procuring Entity's own verification of the reason(s) for the failure to issue documents (vii) and (viii) as described in the <u>SCC</u> provision on Delivery and Documents</p>
<p>3.2</p>	<ol style="list-style-type: none"> 1. The following must be indicated in the performance bond to be posted by the Contractor: <ol style="list-style-type: none"> i. Company Name ii. Correct amount of the Bond iii. Contract/Purchase Order Reference Number iv. Purpose of the Bond: <p>"To guarantee the faithful performance of the Principal's obligation to undertake <u>(Contract/Purchase Order Description)</u> in accordance with the terms and conditions of <u>(Contract No. & Schedule/Purchase Order No.)</u> entered into by the parties."</p> 2. The bond shall remain valid and effective until the duration of the contract <u>(should be specific date reckoned from the contract effectivity)</u> plus sixty (60) days after NPC's acceptance of the last delivery/final acceptance of the project. 3. In case of surety bond, any extension of the contract duration or delivery period granted to the CONTRACTOR shall be considered as given, and any modification of the contract shall be considered as authorized, as if with the expressed consent of the surety, provided that such extension or modifications falls within the effective period of the said surety bond. However, in the event that the extension of the contract duration or delivery schedule would be beyond the effective period of the surety bond first posted, it shall be the sole obligation of the CONTRACTOR to post an acceptable Performance Security within ten (10) calendar days after the contract duration/delivery period extension has been granted by NPC. 4. Other required conditions in addition to the standard policy terms issued by the Bonding Company: <ol style="list-style-type: none"> i. The bond is a penal bond, callable on demand and the entire amount thereof shall be forfeited in favor of the Obligee upon default of the Principal without the need to prove or to show grounds or reasons for demand for the sum specified therein; ii. The amount claimed by the Obligee under this bond shall be paid in full and shall never be subject to any adjustment by the Surety; iii. In case of claim, the Surety shall pay such claim within sixty (60) days from receipt by the Surety of the Obligee's notice of claim/demand letter notwithstanding any objection thereto by the Principal.
<p>4</p>	<p>The inspections and tests that will be conducted are specified in the Technical Specifications.</p>



<p>5.2</p>	<p>The period for correction of defects in the warranty period shall not exceed thirty (30) days upon receipt of the notice from NPC.</p>
	<p>CORRECTION OF PUNCLIST ITEMS:</p> <p>After to the conduct of Test and Commissioning/Joint Final Inspection or upon the advice by the NPC, the Contractor/Supplier must correct any remaining works and work deficiencies identified in the punchlist issued for the project within one (1) month considering the approved remaining contract time.</p> <p>Failure to comply with this provision shall be grounds for non-issuance of Certificate of Satisfactory Performance which is a requirement for future bidding with the NPC. This, however, shall not preclude NPC's claim for liquidated damages, imposition of any other penalties and/or filing of blacklisting actions in accordance with the blacklisting guidelines issued by the Government Procurement Policy Board (GPPB).</p>



SECTION VI

TECHNICAL SPECIFICATIONS

Section VI – Technical Specifications

PART I – TECHNICAL SPECIFICATIONS

TABLE OF CONTENTS

<u>ITEM NO.</u>	<u>TITLE</u>	<u>PAGE NO.</u>
TS-1.0	GENERAL	2
TS-2.0	SCOPE OF WORK.....	2
TS-3.0	PROJECT DURATION AND LOCATION	2
TS-4.0	CODES AND STANDARDS.....	3
TS-5.0	TECHNICAL REQUIREMENTS	3
TS-6.0	MEASUREMENT OF PAYMENT	6

Section VI - Technical Specifications

PART I – TECHNICAL SPECIFICATIONS

TS-1.0 GENERAL

This specification covers the features and technical requirements for the **supply, delivery, installation, testing and commissioning of household electrical connection for various areas in Cagayan.**

The Five (5) areas to be provided with the connection/electrification materials shall be as follows:

1. Babuyan Claro, Cagayan
2. Dibay-Dilam, Cagayan
3. Calayan, Cagayan
4. Balatubat, Cagayan
5. Minabel, Cagayan

The supplied materials and equipment shall be new and unused. It shall be suitable for the intended purpose and shall comply with all applicable regulations, quality and dimension standards.

The Contractor shall accept full responsibility for his work including documentation, preparation for shipment, inspection, warranty provisions and compliance with the applicable codes and standards and the requirements of this Specification.

TS-2.0 SCOPE OF WORK

The scope of works shall cover but not limited to the following :

1. Supply, Delivery, Installation, Testing and Commissioning of Household Connection/Electrification Materials;
2. Appropriate storage area/facility of delivered materials.

It is not NPC's intent to specify all technical requirements nor to set forth those requirements adequately covered by applicable codes and standards. The Contractor shall furnish high quality materials & equipment meeting the requirements of these specification and industry standard.

TS-3.0 PROJECT DURATION AND LOCATION

The project duration shall be **Sixty (60) Calendar Days** reckoned from receipt of Notice to Proceed.

The project shall be located in Five (5) separate existing plant sites as follows:

1. Babuyan Claro, Cagayan
2. Dibay-Dilam, Cagayan
3. Calayan, Cagayan
4. Balatubat, Cagayan
5. Minabel, Cagayan

The Contractor shall be responsible for taking particular reference to its accessibility, means of transportation and all other factors that could hamper the smooth execution of the contract.

Any and/or all expenses arising through the lack of knowledge of the Contractor regarding the existing conditions of the delivery site shall be his responsibility and no additional payment thereof shall be made by NPC.

TS-4.0 CODES AND STANDARDS

The equipment and materials to be furnished shall be designed, manufactured and tested in accordance with, but not limited to, the latest issues of the following codes and standards, including all addenda, in effect at time of purchase order unless otherwise stated in this specification:

1. American National Standards Institute	ANSI
2. Institute of Electrical & Electronic Engineers	IEEE
3. American Society for Testing and Materials	ASTM
4. National Electrical Manufacturers Association	NEMA
5. Underwriters Laboratories, Inc.	UL
6. International Electro-Technical Commission	IEC
7. International Standards Organization	ISO
8. National Electric Code	NEC
9. National Electrical Safety Code	NESC
10. Philippines Electrical Code	PEC
11. American Welding Society	AWS
12. American Zinc Institute	AZI
13. American Society of Civil Engineers	ASCE

These codes and standards set forth the minimum requirements which may be exceeded by the Contractor, if, in the Contractor's judgment and with NPC's acceptance, superior or more economical designs or materials are available as required by this specification.

TS-5.0 TECHNICAL REQUIREMENTS

TS- 5.1 HOUSEHOLD CONNECTION MATERIALS

This specification covers the technical and associated requirements for the complete household wiring materials.

It is not NPC's intent to specify all technical requirements nor to set forth those requirements adequately covered by applicable codes and standards. Contractor shall furnish high quality materials meeting the requirements of this specification and industry standards.

The Contractor shall bear full responsibility that the power conductors have been designed and manufactured in accordance with all codes, standards

and applicable governmental regulations and perform under the condition and to the standards specified herein.

All materials to be used in the work shall be new, of high quality, free from all defects and of proven acceptability for the purpose of intended.

Service Drop Wire

The service drop wire shall be of duplex type with one insulated phase conductor twisted around on a neutral conductor (ACSR). All wires of conductor shall be aluminum and concentrically stranded. Conductor insulation shall be of black polyethylene (PE) and is rated for 600V phase to phase.

The type and size of service drop wire to be supplied shall be as stated in the Technical Data Sheets and shall be manufactured according to applicable ASTM or equivalent IEC Standards

Household Billing Meter

This specification covers the technical and associated requirements for the kilowatt-hour meter and accessories for the electricity billing requirement of each household.

The equipment to be furnished shall be in accordance with, but not limited to, the latest issues of the Applicable Codes and Standards, including all addenda, in effect at time of purchase order unless otherwise stated in this specification.

All materials and parts which are not specifically mentioned herein but are necessary for the proper installation and safe used of kilowatt-hour meter shall be furnished at no additional cost to NPC.

Technical Characteristics and Requirements

- | | |
|-----------------------|----------------------|
| a. Type | : Electronic/Digital |
| b. Accuracy class | : 0.3 or better |
| c. Rated Voltage, V | : 240 |
| d. Current range, A | : 10(30A) |
| e. Frequency, Hz | : 60 |
| f. Phase / no of wire | : 1 / 2 |

The kilowatt-hour meter shall be furnished and installed by the Contractor as shown on the bid drawings complete with housing and mounting accessories for outdoor metering purposes. It shall be capable to measure the power consumed by the household.

The meter shall comply in all aspects with the specification for meters specified in the latest edition of ANSI and/or IEC Standard. The meter to be

supplied shall be tamper-proof and provided with user-friendly interface. It shall be designed to operate continuously for the normal life of the meter in an outdoor tropical location exposed to the elements of rust, corrosion, or other damages which might adversely affect the meter's accuracy or reliability.

Test Requirements

Test report on design and routine tests performed in accordance with ANSI and/or IEC standard shall be submitted to NPC for evaluation and approval.

The Contractor shall submit for approval the brochures and/or catalogues with complete technical specification of the kilowatt-hour meter including accessories to be supplied prior to fabrication and/or delivery at site.

Overcurrent Protective Device

The enclosed overcurrent protective device (circuit breakers) to be supplied shall be rated 600V, 1-ph, 60Hz. Each circuit breaker shall be equipped with thermal-magnetic trip element.

Lighting Fixtures, Luminaires and Accessories

Lighting Fixtures

All lighting fixtures to be supplied shall be free of leaks, warps, dents and other irregularities.

The hangers and brackets of all kinds for safe and proper installation of lighting fixtures shall be furnished by the Contractor at his own expense.

The housing of lighting fixture shall be fabricated of corrosion resistant material and shall provide good ventilation and easy installation.

Lighting fixtures shall be wired with approved fixture wire, 90°C insulation. Each fixture shall be wired to a single point with an adequate slack for proper connection. All lighting fixtures shall be protected from damage upon delivery. Any broken lighting fixtures, receptacles, stems and the like, shall be replaced with new parts, at no cost to NPC.

Lighting Luminaire(s)

a. Compact LED Bulb

The Compact LED Bulb to be supplied shall be rated 240V, 60Hz, 9 Watts, cool white or approved equivalent, classic globe shaped with E27 base and frosted finish complete with all the required mounting accessories.

Household Wiring

Conductors to be supplied shall be stranded annealed copper conductor as stated in the Technical Data Sheets. The minimum size of conductor to be used shall be 3.5mm².

Insulation shall be suitable for wet and dry location, fungi resistant and ultraviolet stable.

All conductors shall be moisture and heat resistant, flame-retardant polyvinyl chloride insulation, chemical and abrasion resistant nylon sheath.

The conductor specification shall meet ASTM specification, PNS 35, UL standard 83 and requirements of PEC.

Junction/ Utility and Pull Boxes

Junction / Utility Boxes

All junction/utility boxes for concealed work shall be of hot dip galvanized steel or un-plasticized polyvinyl Chloride.

Utility boxes shall be firmly anchored in place and where required provided with fixture supports.

Pull Boxes

Pull boxes shall be supplied to prevent damage to the insulation or other damage that might result from pulling resistance or for other reasons related to improper installation. All pull boxes shall be made of galvanized sheet steel not less than 2mm or un-plasticized polyvinyl chloride. Where pull boxes are used in connection with exposed conduits, plain covers attached to the pull box with a suitable number of countersunk flathead machine screws may be used.

Boxes and fitting required for the lighting and power system including all necessary hardware and accessories such as screws, bolts, concrete inserts, clamps, locknuts, couplings shall be furnished by the Contractor. The required quantities of various items and associated materials shall be furnished in accordance with the NPC requirements.

TS-6.0 MEASUREMENT OF PAYMENT

Measurement of payment for the supply, delivery, installation and test of Household Connection Materials will be based on the quantity of each material supplied, delivered, installed and tested as shown in the bid drawings or as otherwise directed. Payment will be made at the unit bid price for each item under Household Connection Materials in the Schedule of Requirements.

PART II – TECHNICAL DATA SHEETS
ELECTRICAL WORKS

A. General

The Bidder is required to provide all the information required under the Column "Contractor's Data". Although not given by NPC, the Contractor's Data shall be based on the International Standards

NPC requirements are indicated below. The Contractor shall indicate their data corresponding to the said NPC requirements to facilitate evaluation of Contractor's compliance to the specifications.

Non compliance to the requirements shall be ground for disqualification

B. Technical Data and Requirements

B.1 Household Connection Materials

B.1.1. Service Drop Wire	NPC Requirements	Contractor's Data
1. Manufacturer	By Contractor	_____
2. Place of Manufacture	By Contractor	_____
3. Type	#6 AWG Duplex	_____
4. Phase conductor		
a. Material	Aluminium	_____
b. Stranding no.	7 Al	_____
c. Insulation	Yes, black polyethylene (PE)	_____
5. Bare Neutral Messenger		
a. Material		
▪ Outer layers	Aluminium	_____
▪ Inner core	Steel	_____

Name of Firm

Name & Signature of Representative

Designation



	NPC Requirements	Contractor's Data
b. Size AWG	2	
c. Stranding no.	6-Al / 1-Stl	
d. Breaking strength, lbs	≥2835	
B.1.2. Kilowatt-hour Demand Meter		
1. Manufacturer	By Contractor	
2. Place of Manufacture	By Contractor	
3. Accuracy Class	0.3 or better	
4. No. of Phase / Wire	1 / 2	
5. Voltage, V	230	
6. Current Range	10 (30)	
7. Frequency, Hz	60	
8. Enclosure degree of protection	IP54	
9. Cable entrance	Bottom	
10. Tamper proof	Yes	
11. Access for maintenance testing	Front access	
12. LCD display	kWh, kW, current, voltage	
13. The Kilowatt-hour meter to be provided is certified and approved by ERC	Yes	
B.1.3. Overcurrent Protective Device		
1. Manufacturer	By Contractor	
2. Place of Manufacture	By Contractor	
3. Type	Enclosed Circuit Breaker	
4. Rated Voltage, V	600	
5. No of phase	1	

Name of Firm	Name & Signature of Representative	Designation
--------------	------------------------------------	-------------



	NPC Requirements	Contractor's Data
6. Ampere trip rating	20 AT	
7. Interrupting capacity, kA	10	
B.1.4. Lighting Fixtures / Luminaires		
1. Manufacturer	By Contractor	
2. Place of Manufacture	By Contractor	
3. Type	Compact LED lamp	
4. Wattage, W	9	
5. Color	Cool White	
6. Efficacy, lm/W	60 - 92	
7. Lumens, lm	≥850	
8. Socket base	E27	
B.1.5. Household Wirings		
1. Manufacturer	By Contractor	
2. Place of Manufacture	By Contractor	
3. Feeder conductor		
▪ Type	THHN/THWN-2	
▪ Size, mm ²	8	
▪ Operating Temperature, °C	90	
▪ Ampacity	By Contractor	
▪ Material	Stranded Copper	
4. Branch Circuit Conductor		
▪ Type	Non-metallic sheathed wire	
▪ Size, mm ²	3.5	
▪ Operating Temperature, °C	60	
▪ Ampacity	By Contractor	
▪ Material	Stranded Copper	

Name of Firm	Name & Signature of Representative	Designation
--------------	------------------------------------	-------------



SECTION VII

SCHEDULE OF REQUIREMENTS

**SECTION VII - SCHEDULE OF REQUIREMENTS
(BID PRICE SCHEDULE)
BPS.1 - SUMMARY**

SUPPLY, DELIVERY, INSTALLATION, TESTING AND COMMISSIONING OF HOUSEHOLD ELECTRICAL CONNECTION FOR CAGAYAN AREAS PROJECT

Item No.	Particulars	Total Amount (In Words)	Total Amount (In Figures)
A	Babuyan Claro, Cagayan	_____	P _____
B	Dibay-Dilam, Cagayan	_____	P _____
C	Calayan, Cagayan	_____	P _____
D	Balatubat, Cagayan	_____	P _____
E	Minabel, Cagayan	_____	P _____
TOTAL AMOUNT OF BID		_____	P _____

Note: Final delivery site of the equipment shall be at the plant sites stated above.

Name of Firm

Name and Signature of Authorized Representative

Designation



SECTION VII - SCHEDULE OF REQUIREMENTS

**SECTION VII - SCHEDULE OF REQUIREMENTS
(BID PRICE SCHEDULE)
BPS.1 - Breakdown of Prices
Babuyan Claro, Cagayan**

Item No.	Description of Work or Materials	QTY.- UNIT	C O D E	UNIT PRICE FOR GOODS AND RELATED SERVICES TO BE SUPPLIED AND DELIVERED						TOTAL PRICE
				Unit Price of Goods Delivered up to Philippine Port +(Phil. Peso)	Import Duties & other Levies Imposed by Phil. Govt. (Phil. Peso)	Value Added Tax and other Taxes Imposed by Phil. Govt. (Phil. Peso)	Local Transport from Port to Delivery Site <(Phil. Peso)	Labor (Installation, Testing and Commissioning) >(Phil. Peso)	Total Unit Price (E+F+G+H+I)	Local Currency (Phil. Peso) (K =J x C)
(A)	(B)	(C)	(D)	(E)	(F)	(G)	(H)	(I)	(J)	(K)
A.	HOUSEHOLD CONNECTION MATERIALS									
A.1	Electronic/Digital Kilowatt-Hour Meter, Outdoor Type, 1-Phase, 230V, 10(30)AT with ERC Approval	16 pcs								
A.2	Duplex Wire, #6 AWG, 7-Al. & 6-Al/1-Stl. Stranding	400 mtrs								
A.3	Service Entrance Cap, Weather-Proof Type, 3/4" Diameter with Locknut and Bushings	16 pcs								
A.4	Rigid Steel Conduit (RSC), 3/4" Diameter x 10' long with eight (8) Pieces C-Clamp (Galvanized Iron with Screw), Locknut, Elbow, and Bushings	16 pcs								
A.5	8mm ² 600V THHN/THWN-2 Copper Wire For Service Entrance	112 mtrs								
A.6	3.5mm ² (#12) 600V type NM wire for Household wiring	320 mtrs								
A.7	20AT, 2-Pole, Single-Phase Miniature Circuit Breaker (MCB) with Enclosure	16 pcs								
A.8	Wire Holder, Universal Service Type No. 22	16 pcs								
A.9	Tapping Connector, Compression-Type for No. #2 AWG to #6 AWG	32 pcs								
A.10	Electrical Tape, Big	32 pcs								
A.11	9 Watts Cool White LED Bulb, E27 Basem complete with the required receptacle, junction box, fittings etc.	32 pcs								
A.12	Surface Mounted Outlet, Duplex, 240V, 1-phase	16 pcs								
A.13	Surface Mounted 1 Gang Switch, 240V, 1-phase	32 pcs								
A.14	Insulated Staple Wire	6 box								
A.15	PVC Octagonal utility box complete with the required mounting accessories,cover, etc.	32 pcs								
SUB-TOTAL				(Amount in Words)						

Note: Final delivery site of the equipment shall be at the plant site stated above.

* Bidders shall enter a code representing the Country of Origin of all imported equipment, materials and accessories

+ Cost of equipment, freight, insurance, etc. up to Phil. port of entry.

< Unit Price for Local Transportation, insurance and other local costs incidental to delivery of the goods from the Phil port of entry to final delivery site

> Unit Price for Local Transportation, insurance and other local costs incidental to delivery of the goods from local source to final delivery site

Code	Country of Origin

Name of Firm

Name and Signature of Authorized Representative

Designation



**SECTION VII - SCHEDULE OF REQUIREMENTS
(BID PRICE SCHEDULE)
BPS.1 - Breakdown of Prices
Dibay-Dilam, Cagayan**

Item No.	Description of Work or Materials	QTY.- UNIT	C O D E	UNIT PRICE FOR GOODS AND RELATED SERVICES TO BE SUPPLIED AND DELIVERED						TOTAL PRICE
				Unit Price of Goods Delivered up to Philippine Port +(Phil. Peso)	Import Duties & other Levies Imposed by Phil. Govt. (Phil. Peso)	Value Added Tax and other Taxes Imposed by Phil. Govt. (Phil. Peso)	Local Transport from Port to Delivery Site <(Phil. Peso)	Labor (Installation, Testing and Commissioning) >(Phil. Peso)	Total Unit Price (E+F+G+H+I)	
(A)	(B)	(C)	(D)	(E)	(F)	(G)	(H)	(I)	(J)	(K)
B.	HOUSEHOLD CONNECTION MATERIALS									
B.1	Electronic/Digital Kilowatt-Hour Meter, Outdoor Type, 1-Phase, 230V, 10(30)AT with ERC Approval	16 pcs								
B.2	Duplex Wire, #6 AWG, 7-AJ, & 6-AJ/1-Stl. Stranding	400 mtrs								
B.3	Service Entrance Cap, Weather-Proof Type, 3/4" Diameter with Locknut and Bushings	16 pcs								
B.4	Rigid Steel Conduit (RSC), 3/4" Diameter x 10' long with eight (8) Pieces C-Clamp (Galvanized Iron with Screw), Locknut, Elbow, and Bushings	16 pcs								
B.5	8mm ² 600V THHN/THWN-2 Copper Wire For Service Entrance	112 mtrs								
B.6	3.5mm ² (#12) 600V type NM wire for Household wiring	320 mtrs								
B.7	20AT, 2-Pole, Single-Phase Miniature Circuit Breaker (MCB) with Enclosure	16 pcs								
B.8	Wire Holder, Universal Service Type No. 22	16 pcs								
B.9	Tapping Connector, Compression-Type for No. #2 AWG to #5 AWG	32 pcs								
B.10	Electrical Tape, Big	32 pcs								
B.11	9 Watts Cool White LED Bulb, E27 Base complete with the required receptacle, junction box, fittings etc.	32 pcs								
B.12	Surface Mounted Outlet, Duplex, 240V, 1-phase	16 pcs								
B.13	Surface Mounted 1 Gang Switch, 240V, 1-phase	32 pcs								
B.14	Insulated Staple Wire	8 box								
B.15	PVC Octagonal utility box complete with the required mounting accessories, cover, etc.	32 pcs								
SUB-TOTAL				(Amount in Words)						

Note: Final delivery site of the equipment shall be at the plant site stated above.

* Bidders shall enter a code representing the Country of Origin of all imported equipment, materials and accessories

< Cost of equipment, freight, insurance, etc. up to Phil. port of entry.

< Unit Price for Local Transportation, insurance and other local costs incidental to delivery of the goods from the Phil port of entry to final delivery site

> Unit Price for Local Transportation, insurance and other local costs incidental to delivery of the goods from local source to final delivery site

Code	Country of Origin

Name of Firm

Name and Signature of Authorized Representative

Designation



**SECTION VII - SCHEDULE OF REQUIREMENTS
(BID PRICE SCHEDULE)
BPS.1 - Breakdown of Prices
Calayan, Cagayan**

Item No.	Description of Work or Materials	QTY.- UNIT	C O D E	UNIT PRICE FOR GOODS AND RELATED SERVICES TO BE SUPPLIED AND DELIVERED						TOTAL PRICE
				Unit Price of Goods Delivered up to Philippine Port +(Phil. Peso)	Import Duties & other Levies Imposed by Phil. Govt. (Phil. Peso)	Value Added Tax and other Taxes Imposed by Phil. Govt. (Phil. Peso)	Local Transport from Port to Delivery Site <(Phil. Peso)	Labor (Installation, Testing and Commissioning) >(Phil. Peso)	Total Unit Price (E+F+G+H+I)	Local Currency (Phil. Peso) (K =J x C)
(A)	(B)	(C)	(D)	(E)	(F)	(G)	(H)	(I)	(J)	(K)
C.	HOUSEHOLD CONNECTION MATERIALS									
C.1	Electronic/Digital Kilowatt-Hour Meter, Outdoor Type, 1-Phase, 230V, 10(30)AT with ERC Approval	107 pcs								
C.2	Duplex Wire, #6 AWG, 7-AI, & 6-AI/1-Stl. Stranding	2675 mtrs								
C.3	Service Entrance Cap, Weather-Proof Type, 3/4" Diameter with Locknut and Bushings	107 pcs								
C.4	Rigid Steel Conduit (RSC), 3/4" Diameter x 10' long with eight (8) Pieces C-Clamp (Galvanized Iron with Screw), Locknut, Elbow, and Bushings	107 pcs								
C.5	8mm² 600V THHN/THWN-2 Copper Wire For Service Entrance	749 mtrs								
C.6	3.5mm² (#12) 600V type NM wire for Household wiring	2140 mtrs								
C.7	20AT, 2-Pole, Single-Phase Miniature Circuit Breaker (MCB) with Enclosure	107 pcs								
C.8	Wire Holder, Universal Service Type No. 22	107 pcs								
C.9	Tapping Connector, Compression-Type for No. #2 AWG to #6 AWG	214 pcs								
C.10	Electrical Tape, Big	214 pcs								
C.11	9 Watts Cool White LED Bulb, E27 Basem complete with the required receptacle, junction box, fittings etc.	214 pcs								
C.12	Surface Mounted Outlet, Duplex, 240V, 1-phase	107 pcs								
C.13	Surface Mounted 1 Gang Switch, 240V, 1-phase	214 pcs								
C.14	Insulated Staple Wire	54 box								
C.15	PVC Octagonal utility box complete with the required mounting accessories,cover, etc.	214 pcs								
SUB-TOTAL				(Amount in Words)						

Note: Final delivery site of the equipment shall be at the plant site stated above.

- * Bidders shall enter a code representing the Country of Origin of all imported equipment, materials and accessories
- < Cost of equipment, freight, insurance, etc. up to Phil. port of entry.
- < Unit Price for Local Transportation, insurance and other local costs incidental to delivery of the goods from the Phil port of entry to final delivery site
- > Unit Price for Local Transportation, insurance and other local costs incidental to delivery of the goods from local source to final delivery site

Code	Country of Origin

Name of Firm

Name and Signature of Authorized Representative

Designation



**SECTION VII - SCHEDULE OF REQUIREMENTS
(BID PRICE SCHEDULE)
BPS.1 - Breakdown of Prices
Balatubat, Cagayan**

Item No.	Description of Work or Materials	QTY.- UNIT	C O D E	UNIT PRICE FOR GOODS AND RELATED SERVICES TO BE SUPPLIED AND DELIVERED						TOTAL PRICE
				Unit Price of Goods Delivered up to Philippine Port *(Phil. Peso)	Import Duties & other Levies Imposed by Phil. Govt. (Phil. Peso)	Value Added Tax and other Taxes Imposed by Phil. Govt. (Phil. Peso)	Local Transport from Port to Delivery Site <(Phil. Peso)	Labor (Installation, Testing and Commissioning) >(Phil. Peso)	Total Unit Price (E+F+G+H+I)	
(A)	(B)	(C)	(D)	(E)	(F)	(G)	(H)	(I)	(J)	(K)
D.	HOUSEHOLD CONNECTION MATERIALS									
D.1	Electronic/Digital Kilowatt-Hour Meter, Outdoor Type, 1-Phase, 230V, 10(30)AT with ERC Approval	50 pcs								
D.2	Duplex Wire, #6 AWG, 7-AJ, & 6-AJ/1-Str. Stranding	1250 mtrs								
D.3	Service Entrance Cap, Weather-Proof Type, 3/4" Diameter with Locknut and Bushings	50 pcs								
D.4	Rigid Steel Conduit (RSC), 3/4" Diameter x 10' long with eight (8) Pieces C-Clamp (Galvanized Iron with Screw), Locknut, Elbow, and Bushings	50 pcs								
D.5	8mm ² 600V THHN/THWN-2 Copper Wire For Service Entrance	350 mtrs								
D.6	3.5mm ² (#12) 600V type NM wire for Household wiring	1000 mtrs								
D.7	20AT, 2-Pole, Single-Phase Miniature Circuit Breaker (MCB) with Enclosure	50 pcs								
D.8	Wire Holder, Universal Service Type No. 22	50 pcs								
D.9	Tapping Connector, Compression-Type for No. #2 AWG to #6 AWG	100 pcs								
D.10	Electrical Tape, Big	100 pcs								
D.11	9 Watts Cool White LED Bulb, E27 Basem complete with the required receptacle, junction box, fittings etc.	100 pcs								
D.12	Surface Mounted Outlet, Duplex, 240V, 1-phase	50 pcs								
D.13	Surface Mounted 1 Gang Switch, 240V, 1-phase	100 pcs								
D.14	Insulated Staple Wire	25 box								
D.15	PVC Octagonal utility box complete with the required mounting accessories,cover, etc.	100 pcs								
SUB-TOTAL				(Amount in Words)						

Note: Final delivery site of the equipment shall be at the plant site stated above.

* Bidders shall enter a code representing the Country of Origin of all imported equipment, materials and accessories

+ Cost of equipment, freight, insurance, etc. up to Phil. port of entry.

< Unit Price for Local Transportation, insurance and other local costs incidental to delivery of the goods from the Phil port of entry to final delivery site

> Unit Price for Local Transportation, insurance and other local costs incidental to delivery of the goods from local source to final delivery site

Code	Country of Origin

Name of Firm

Name and Signature of Authorized Representative

Designation



SECTION VII - SCHEDULE OF REQUIREMENTS

**SECTION VII - SCHEDULE OF REQUIREMENTS
(BID PRICE SCHEDULE)
BPS.1 - Breakdown of Prices
Minabel, Cagayan**

Item No.	Description of Work or Materials	QTY.- UNIT	C O D E	UNIT PRICE FOR GOODS AND RELATED SERVICES TO BE SUPPLIED AND DELIVERED						TOTAL PRICE
				Unit Price of Goods Delivered up to Philippine Port *(Phil. Peso)	Import Duties & other Levies Imposed by Phil. Govt. (Phil. Peso)	Value Added Tax and other Taxes Imposed by Phil. Govt. (Phil. Peso)	Local Transport from Port to Delivery Site <(Phil. Peso)	Labor (Installation, Testing and Commissioning) >(Phil. Peso)	Total Unit Price (E+F+G+H+I)	
(A)	(B)	(C)	(D)	(E)	(F)	(G)	(H)	(I)	(J)	(K)
E.	HOUSEHOLD CONNECTION MATERIALS									
E.1	Electronic/Digital Kilowatt-Hour Meter, Outdoor Type, 1-Phase, 230V, 10(30)AT with ERC Approval	9 pcs								
E.2	Duplex Wire, #6 AWG, 7-Al. & 6-Al./1-Stl. Stranding	225 mtrs								
E.3	Service Entrance Cap, Weather-Proof Type, 3/4" Diameter with Locknut and Bushings	9 pcs								
E.4	Rigid Steel Conduit (RSC), 3/4" Diameter x 10' long with eight (8) Pieces C-Clamp (Galvanized Iron with Screw), Locknut, Elbow, and Bushings	9 pcs								
E.5	8mm ² 600V THHN/THWN-2 Copper Wire For Service Entrance	63 mtrs								
E.6	3.5mm ² (#12) 600V type NM wire for Household wiring	180 mtrs								
E.7	20AT, 2-Pole, Single-Phase Miniature Circuit Breaker (MCB) with Enclosure	9 pcs								
E.8	Wire Holder, Universal Service Type No. 22	9 pcs								
E.9	Tapping Connector, Compression-Type for No. #2 AWG to #6 AWG	18 pcs								
E.10	Electrical Tape, Big	18 pcs								
E.11	9 Watts Cool White LED Bulb, E27 Base complete with the required receptacle, junction box, fittings etc.	18 pcs								
E.12	Surface Mounted Outlet, Duplex, 240V, 1-phase	9 pcs								
E.13	Surface Mounted 1 Gang Switch, 240V, 1-phase	9 pcs								
E.14	Insulated Staple Wire	5 box								
E.15	PVC Octagonal utility box complete with the required mounting accessories, cover, etc.	18 pcs								
SUB-TOTAL				(Amount in Words)						

Note: Final delivery site of the equipment shall be at the plant site stated above.

- * Bidders shall enter a code representing the Country of Origin of all imported equipment, materials and accessories
- + Cost of equipment, freight, insurance, etc. up to Phil. port of entry.
- < Unit Price for Local Transportation, insurance and other local costs incidental to delivery of the goods from the Phil port of entry to final delivery site
- > Unit Price for Local Transportation, insurance and other local costs incidental to delivery of the goods from local source to final delivery site

Code	Country of Origin

Name of Firm

Name and Signature of Authorized Representative

Designation



SECTION VIII

BIDDING FORMS

SECTION VIII – BIDDING FORMS

TABLE OF CONTENTS

NPCSF-GOODS-01	- Checklist of Technical and Financial Envelope Requirements for Bidders
NPCSF-GOODS-02	- List of all Ongoing Government & Private Contracts Including Contracts Awarded but not yet Started
NPCSF-GOODS-03	- Statement of the bidder's Single Largest Completed Contract (SLCC) similar to the contract to be bid
NPCSF-GOODS-04	- Computation of Net Financial Contracting Capacity (NFCC)
NPCSF-GOODS-05	- Joint Venture Agreement
NPCSF-GOODS-06a	- Form of Bid Security : Bank Guarantee
NPCSF-GOODS-06b	- Form of Bid Security : Surety Bond
NPCSF-GOODS-06c	- Bid Securing Declaration Form
NPCSF-GOODS-07	- Omnibus Sworn Statement (Revised)
NPCSF-GOODS-08	- Bid Letter
Sample Form	- Bank Guarantee Form for Advance Payment
Sample Form	- Certification from DTI as Domestic Bidder

Standard Form No: NPCSF-GOODS-01

Checklist of Technical & Financial Envelope Requirements for Bidders

A. THE 1ST ENVELOPE (TECHNICAL COMPONENT) SHALL CONTAIN THE FOLLOWING:

1. ELIGIBILITY DOCUMENTS

a. (CLASS A)

- PhilGEPs Certificate of Registration and Membership under Platinum Category (all pages) in accordance with Section 8.5.2 of the Revised IRR of RA. 9184;

Note: The failure by the prospective bidder to update its Certificate with the current and updated Class "A" eligibility documents shall result in the automatic suspension of the validity of its Certificate until such time that all of the expired Class "A" eligibility documents has been updated

- Statement of all its ongoing government and private contracts if any, whether similar or not similar in nature and complexity to the contract to be bid (*NPCSF-GOODS-02*)
- The Statement of the bidder's Single Largest Completed Contract (SLCC) similar to the contract to be bid, and whose value, adjusted to current prices using the Philippine Statistics Authority (PSA) consumer price index, must be at least 50% of the ABC (*NPCSF-GOODS-03*) complete with the following supporting documents:

1. Certificate of Acceptance; or Certificate of Completion; or Official Receipt (O.R); or Sales Invoice

(The Single Largest Completed Contract (SLCC) as declared by the bidder shall be verified and validated to ascertain such completed contract. Hence, bidders must ensure access to sites of such projects/equipment to NPC representatives for verification and validation purposes during post-qualification process.

It shall be a ground for disqualification, if verification and validation cannot be conducted for reasons attributable to the Bidder.)

- Duly signed computation of its Net Financial Contracting Capacity (NFCC) at least equal to the ABC (*NPCSF-GOODS-04*) or a Committed Line of Credit (CLC) at least equal to ten percent (10%) of the ABC, issued by a Universal or Commercial Bank; If the Bidder opted to submit a Committed Line of Credit (CLC), the bidder must submit a granted credit line valid/effective at the date of bidding.

b. (CLASS B)

- For Joint Venture (if applicable), any of the following:
 - Valid Joint Venture Agreement (*NPCSF-GOODS-05*)

OR

 - Notarized statements from all the potential joint venture partners stating that they will enter into and abide by the provisions of the JVA, if awarded the contract
- Certification from the relevant government office of their country stating that Filipinos are allowed to participate in their government procurement activities for the same item/product (*For foreign bidders claiming eligibility by reason of their country's extension of reciprocal rights to Filipinos*)

Standard Form No: NPCSF-GOODS-01

2. Technical Documents

- Bid Security, any one of the following:
 - Bid Securing Declaration (NPCSF-GOODS-06c)
OR
 - Cash or Cashier's/Manager's check issued by a Universal or Commercial Bank – 2% of ABC;
OR
 - Bank draft/guarantee or irrevocable letter of credit issued by a Universal or Commercial Bank: (NPCSF-GOODS-06a) - 2% of ABC;
OR
 - Surety Bond callable upon demand issued by a reputable surety or insurance company (NPCSF-GOODS-06b) - 5% of ABC, with
 - Certification from the Insurance Commission as authorized company to issue surety
- Duly signed, completely filled-out and notarized Omnibus Sworn statement (Revised) (NPCSF-GOODS-07), complete with the following attachments:
 - For Sole Proprietorship:
 - Special Power of Attorney
 - For Partnership/Corporation/Cooperative/Joint Venture:
 - Document showing proof of authorization (e.g., duly notarized Secretary's Certificate, Board/Partnership Resolution, or Special Power of Attorney, whichever is applicable)
- Duly signed and completely filled-out Technical Data Sheets (Section VI – Part II TDS)
- Complete eligibility documents of the proposed subcontractor, if any

B. THE 2ND ENVELOPE (FINANCIAL COMPONENT) SHALL CONTAIN THE FOLLOWING:

- Duly signed Bid Letter indicating the total bid amount in accordance with the prescribed form (NPCSF-GOODS-08)
- Duly signed and completely filled-out Schedule of Requirement (Section VII) indicating the unit and total prices per item and the total amount in the prescribed Price Schedule form.
- For Domestic Bidder claiming for domestic preference:
 - Letter address to the BAC claiming for preference
 - Certification from DTI as Domestic Bidder in accordance with the prescribed forms provided

Standard Form No: NPCSF-GOODS-01

CONDITIONS:

1. Each Bidder shall submit Two (2) copies of the first and second components of its Bid, marked Original and photocopy. Only the original copy will be read and considered for the bid. Any misplaced document outside of the Original copy will not be considered. The photocopy is ONLY FOR REFERENCE. NPC may request additional hard copies and/or electronic copies of the Bid. However, failure of the Bidders to comply with the said request shall not be a ground for disqualification.
2. In the case of foreign bidders, the eligibility requirements under Class "A" Documents (except for Tax Clearance) may be substituted by the appropriate equivalent documents, if any, issued by the country of the foreign bidder concerned. The eligibility requirements or statements, the bids, and all other documents to be submitted to the BAC must be in English. If the eligibility requirements or statements, the bids, and all other documents submitted to the BAC are in foreign language other than English, it must be accompanied by a translation of the documents in English. The documents shall be translated by the relevant foreign government agency, the foreign government agency authorized to translate documents, or a registered translator in the foreign bidder's country; and shall be authenticated by the appropriate Philippine foreign service establishment/post or the equivalent office having jurisdiction over the foreign bidder's affairs in the Philippines.

These documents shall be accompanied by a Sworn Statement in a form prescribed by the GPPB stating that the documents submitted are complete and authentic copies of the original, and all statements and information provided therein are true and correct. Upon receipt of the said documents, the PhilGEPS shall process the same in accordance with the guidelines on the Government of the Philippines – Official Merchants Registry (GoP-OMR).
3. A Bidder not submitting bid for reason that his cost estimate is higher than the ABC, is required to submit his letter of non-participation/regret supported by corresponding detailed estimates. Failure to submit the two (2) documents shall be understood as acts that tend to defeat the purpose of public bidding without valid reason as stated under Section 69.1.(i) of the revised IRR of R.A. 9184.

SECTION VIII – BIDDING FORMS

Standard Form Number: NPCSF-GOODS-02

List of All Ongoing Government and Private Contracts Including Contract Awarded But Not Yet Started

Business Name : _____
 Business Address : _____

Name of Contract/ Project Cost	a. Owner's Name b. Address c. Telephone Nos.	Nature of Work	Bidder's Role		a. Date Awarded b. Date Started c. Date of Completion or Contract Duration/ Date of Delivery	Value of Outstanding Works / Undelivered Portion
			Description	%		
Government						
Private						
Total Cost						

The bidder shall declare in this form all his on-going government and private contracts including contracts where the bidder (either as individual or as a Joint Venture) is a partner in a Joint Venture agreement other than his current joint venture where he is a partner. Non declaration will be a ground for disqualification of bid.

Note : This statement shall be supported with the following documents for all the contract(s) stated above which shall be submitted during Post-qualification:
 1. Contract/Purchase Order and/or Notice of Award
 2. Certification coming from the project owner/client that the performance is satisfactory as of the bidding date.

Submitted by : _____
 (Printed Name & Signature)
 Designation : _____
 Date : _____

SECTION VIII – BIDDING FORMS

Standard Form Number: NPCSF-GOODS-03

The Statement of the bidder's Single Largest Completed Contract (SLCC) similar to the contract to be bid

Business Name : _____
 Business Address : _____

Name of Contract	a. Owner's Name b. Address c. Telephone Nos.	Nature of Work	Contractor's Role		a. Amount at Award b. Amount at Completion c. Duration	a. Date Awarded b. Contract Effectivity c. Date Completed
			Description	%		

- Notes: 1. The bidder must state only one (1) Single Largest Completed Contract (SLCC) similar to the contract to be bid.
 2. Supporting documents such as any of the following: Certificate of Acceptance; or Certificate of Completion; or Official Receipt (O.R); or Sales Invoice for the contract stated above shall be submitted during Bid Opening.

Submitted by : _____
(Printed Name & Signature)
 Designation : _____
 Date : _____

Standard Form Number: NPCSF-GOODS-04

NET FINANCIAL CONTRACTING CAPACITY (NFCC)

A. Summary of the Supplier's/Distributor's/Manufacturer's assets and liabilities on the basis of the income tax return and audited financial statement for the immediately preceding calendar year are:

		Year 20__
1.	Total Assets	
2.	Current Assets	
3.	Total Liabilities	
4.	Current Liabilities	
5.	Net Worth (1-3)	
6.	Net Working Capital (2-4)	

B. The Net Financial Contracting Capacity (NFCC) based on the above data is computed as follows:

NFCC = [(Current assets minus current liabilities) x 15] minus the value of all outstanding or uncompleted portions of the projects under ongoing contracts, including awarded contracts yet to be started coinciding with the contract for this Project.

NFCC = P _____

Herewith attached is certified true copy of the audited financial statement, stamped "RECEIVED" by the BIR or BIR authorized collecting agent for the immediately preceding calendar year.

Submitted by:

Name of Supplier / Distributor / Manufacturer

Signature of Authorized Representative

Date : _____

Standard Form Number: NPCSF-GOODS-05

JOINT VENTURE AGREEMENT

KNOW ALL MEN BY THESE PRESENTS:

That this JOINT VENTURE AGREEMENT is entered into by and between: _____, of legal age, *(civil status)* _____, authorized representative of _____ and a resident of _____.

- and -

_____, of legal age, *(civil status)* _____, authorized representative of _____ a resident of _____.

That both parties agree to join together their capital, manpower, equipment, and other resources and efforts to enable the Joint Venture to participate in the Bidding and Undertaking of the hereunder stated Contract of the **National Power Corporation**.

NAME OF PROJECT

CONTRACT AMOUNT

That the capital contribution of each member firm:

NAME OF FIRM	CAPITAL CONTRIBUTION
1. _____	₱ _____
2. _____	₱ _____

That both parties agree to be jointly and severally liable for their participation in the Bidding and Undertaking of the said contract.

That both parties agree that _____ and/or _____ shall be the Official Representative/s of the Joint Venture, and are granted full power and authority to do, execute and perform any and all acts necessary and/or to represent the Joint Venture in the Bidding and Undertaking of the said contract, as fully and effectively and the Joint Venture may do and if personally present with full power of substitution and revocation.

That this Joint Venture Agreement shall remain in effect only for the above stated Contract until terminated by both parties.

Name & Signature of Authorized Representative

Official Designation

Name of Firm

Name & Signature of Authorized Representative

Official Designation

Name of Firm

Witnesses

1. _____

2. _____

[Jurat]

[Format shall be based on the latest Rules on Notarial Practice]

Standard Form Number: NPCSF-GOODS-06a

FORM OF BID SECURITY (BANK GUARANTEE)

WHEREAS, (Name of Bidder) (hereinafter called "the Bidder") has submitted his bid dated (Date) for the [name of project] (hereinafter called "the Bid").

KNOW ALL MEN by these presents that We (Name of Bank) of (Name of Country) having our registered office at _____ (hereinafter called "the Bank" are bound unto National Power Corporation (hereinafter called "the Entity") in the sum of [amount in words & figures as prescribed in the bidding documents] for which payment well and truly to be made to the said Entity the Bank binds himself, his successors and assigns by these presents.

SEALED with the Common Seal of the said Bank this _____ day of _____ 20____.

THE CONDITIONS of this obligation are that:

- 1) if the Bidder withdraws his Bid during the period of bid validity specified in the Bidding Documents; or
- 2) if the Bidder does not accept the correction of arithmetical errors of his bid price in accordance with the Instructions to Bidder; or
- 3) if the Bidder, having determined as the LCB, fails or refuses to submit the required tax clearance, latest income and business tax returns and PhilGEPs registration certificate within the prescribed period; or
- 4) if the Bidder having been notified of the acceptance of his bid and award of contract to him by the Entity during the period of bid validity:
 - a) fails or refuses to execute the Contract; or
 - b) fails or refuses to submit the required valid JVA, if applicable; or
 - c) fails or refuses to furnish the Performance Security in accordance with the Instructions to Bidders;

we undertake to pay to the Entity up to the above amount upon receipt of his first written demand, without the Entity having to substantiate its demand, provided that in his demand the Entity will note that the amount claimed by it is due to the occurrence of any one or combination of the four (4) conditions stated above.

The Guarantee will remain in force up to 120 days after the opening of bids or as it may be extended by the Entity, notice of which extension(s) to the Bank is hereby waived. Any demand in respect of this Guarantee should reach the Bank not later than the above date.

DATE _____ SIGNATURE OF THE BANK _____

WITNESS _____ SEAL _____

 (Signature, Name and Address)

Standard Form Number: NPCSF-GOODS-06b

FORM OF BID SECURITY (SURETY BOND)

BOND NO.: _____ DATE BOND EXECUTED: _____

By this bond, We (Name of Bidder) _____ (hereinafter called "the Principal") and (Name of Surety) _____ of (Name of Country of Surety) _____, authorized to transact business in the Philippines (hereinafter called "the Surety") are held and firmly bound unto National Power Corporation (hereinafter called "the Employer") as Obligee, in the sum of (amount in words & figures as prescribed in the bidding documents), callable on demand, for the payment of which sum, well and truly to be made, we, the said Principal and Surety bind ourselves, our successors and assigns, jointly and severally, firmly by these presents.

SEALED with our seals and dated this _____ day of _____ 20 _____

WHEREAS, the Principal has submitted a written Bid to the Employer dated the _____ day of _____ 20 _____, for the _____ (hereinafter called "the Bid").

NOW, THEREFORE, the conditions of this obligation are:

- 1) if the Bidder withdraws his Bid during the period of bid validity specified in the Bidding Documents; or
- 2) if the Bidder does not accept the correction of arithmetical errors of his bid price in accordance with the Instructions to Bidder; or
- 3) if the Bidder, having determined as the LCB, fails or refuses to submit the required tax clearance, latest income and business tax returns and PhilGEPs registration certificate within the prescribed period; or
- 4) if the Bidder having been notified of the acceptance of his bid and award of contract to him by the Entity during the period of bid validity:
 - d) fails or refuses to execute the Contract; or
 - e) fails or refuses to submit the required valid JVA, if applicable; or
 - f) fails or refuses to furnish the Performance Security in accordance with the Instructions to Bidders;

then this obligation shall remain in full force and effect, otherwise it shall be null and void.

PROVIDED HOWEVER, that the Surety shall not be:

- a) liable for a greater sum than the specified penalty of this bond, nor
- b) liable for a greater sum than the difference between the amount of the said Principal's Bid and the amount of the Bid that is accepted by the Employer.

SECTION VIII – BIDDING FORMS

Standard Form Number: NPCSF-GOODS-06b
Page 2 of 2

This Surety executing this instrument hereby agrees that its obligation shall be valid for 120 calendar days after the deadline for submission of Bids as such deadline is stated in the Instructions to Bidders or as it may be extended by the Employer, notice of which extension(s) to the Surety is hereby waived.

PRINCIPAL _____ SURETY _____

SIGNATURE(S) _____ SIGNATURES(S) _____

NAME(S) AND TITLE(S) _____ NAME(S) _____

SEAL _____ SEAL _____

Standard Form No: NPCSF-GOODS-06c

REPUBLIC OF THE PHILIPPINES)
CITY OF _____) S.S.

BID-SECURING DECLARATION
SUPPLY, DELIVERY, INSTALLATION, TESTING AND COMMISSIONING OF
HOUSEHOLD ELECTRICAL CONNECTION FOR CAGAYAN AREAS PROJECT
(LuzP24Z1728Sm)

To: **National Power Corporation**
Gabriel Y. Itchon Building
Sen. Miriam P. Defensor-Santiago Blvd.
(formerly BIR Road) corner Quezon Avenue
Diliman, Quezon City, Philippines 1100

I/We¹, the undersigned, declare that:

1. I/We understand that, according to your conditions, bids must be supported by a Bid Security, which may be in the form of a Bid-Securing Declaration.
2. I/We accept that: (a) I/we will be automatically disqualified from bidding for any contract with any procuring entity for a period of two (2) years upon receipt of your Blacklisting Order; and, (b) I/we will pay the applicable fine provided under Section 6 of the Guidelines on the Use of Bid Securing Declaration, within fifteen (15) days from receipt of the written demand by the Procuring Entity for the commission of acts resulting to the enforcement of the Bid Securing Declaration under Sections 23.1 (b), 34.2, 40.1 and 69.1, except 69.1 (f) of the IRR of R.A. 9184; without prejudice to other legal action the government may undertake.
3. I/We understand that this Bid-Securing Declaration shall cease to be valid on the following circumstances:
 - (a) Upon expiration of the bid validity period, or any extension thereof pursuant to your request;
 - (b) I am/we are declared ineligible or post-disqualified upon receipt of your notice to such effect, and (i) I/we failed to timely file a request for reconsideration or (ii) I/we filed a waiver to avail of said right;
 - (c) I am/we are declared as the bidder with the Lowest Calculated and Responsive Bid, and I/we have furnished the performance security and signed the Contract.

IN WITNESS WHEREOF, I/we have hereunto set my hand this ____ day of ____
20____ at _____, Philippines.

[Name and Signature of Bidder's Representative/
Authorized Signatory]
[Signatory's legal capacity]
Affiant

[Jurat]

[Format shall be based on the latest Rules on Notarial Practice]

¹ Select one and delete the other. Adopt same instruction for similar terms throughout the document.

Standard Form No: NPCSF-GOODS-07

Omnibus Sworn Statement (Revised)

REPUBLIC OF THE PHILIPPINES)
CITY/MUNICIPALITY OF _____) S.S.

AFFIDAVIT

I, [Name of Affiant], of legal age, [Civil Status], [Nationality], and residing at [Address of Affiant], after having been duly sworn in accordance with law, do hereby depose and state that:

1. *[Select one, delete the other:]*

[If a sole proprietorship:] I am the sole proprietor or authorized representative of [Name of Bidder] with office address at [address of Bidder];

[If a partnership, corporation, cooperative, or joint venture:] I am the duly authorized and designated representative of [Name of Bidder] with office address at [address of Bidder];

2. *[Select one, delete the other:]*

[If a sole proprietorship:] As the owner and sole proprietor, or authorized representative of [Name of Bidder], I have full power and authority to do, execute and perform any and all acts necessary to participate, submit the bid, and to sign and execute the ensuing contract for [Name of the Project] of the [Name of the Procuring Entity], as shown in the attached duly notarized Special Power of Attorney;

[If a partnership, corporation, cooperative, or joint venture:] I am granted full power and authority to do, execute and perform any and all acts necessary to participate, submit the bid, and to sign and execute the ensuing contract for [Name of the Project] of the [Name of the Procuring Entity], as shown in the attached [state title of attached document showing proof of authorization (e.g., duly notarized Secretary's Certificate, Board/Partnership Resolution, or Special Power of Attorney, whichever is applicable)];

3. [Name of Bidder] is not "blacklisted" or barred from bidding by the Government of the Philippines or any of its agencies, offices, corporations, or Local Government Units, foreign government/foreign or international financing institution whose blacklisting rules have been recognized by the Government Procurement Policy Board, by itself or by relation, membership, association, affiliation, or controlling interest with another blacklisted person or entity as defined and provided for in the Uniform Guidelines on Blacklisting;

4. Each of the documents submitted in satisfaction of the bidding requirements is an authentic copy of the original, complete, and all statements and information provided therein are true and correct;

5. [Name of Bidder] is authorizing the Head of the Procuring Entity or its duly authorized representative(s) to verify all the documents submitted;

6. *[Select one, delete the rest:]*

[If a sole proprietorship:] The owner or sole proprietor is not related to the Head of the Procuring Entity, members of the Bids and Awards Committee (BAC), the Technical Working Group, and the BAC Secretariat, the head of the Project Management Office or the end-user unit, and the project consultants by consanguinity or affinity up to the third civil degree;

[If a partnership or cooperative:] None of the officers and members of [Name of Bidder] is related to the Head of the Procuring Entity, members of the Bids and Awards Committee

SECTION VIII – BIDDING FORMS

(BAC), the Technical Working Group, and the BAC Secretariat, the head of the Project Management Office or the end-user unit, and the project consultants by consanguinity or affinity up to the third civil degree;

[If a corporation or joint venture:] None of the officers, directors, and controlling stockholders of *[Name of Bidder]* is related to the Head of the Procuring Entity, members of the Bids and Awards Committee (BAC), the Technical Working Group, and the BAC Secretariat, the head of the Project Management Office or the end-user unit, and the project consultants by consanguinity or affinity up to the third civil degree;

7. *[Name of Bidder]* complies with existing labor laws and standards; and
8. *[Name of Bidder]* is aware of and has undertaken the responsibilities as a Bidder in compliance with the Philippine Bidding Documents, which includes:
 - a. Carefully examining all of the Bidding Documents;
 - b. Acknowledging all conditions, local or otherwise, affecting the implementation of the Contract;
 - c. Making an estimate of the facilities available and needed for the contract to be bid, if any; and
 - d. Inquiring or securing Supplemental/Bid Bulletin(s) issued for the *[Name of the Project]*.
9. *[Name of Bidder]* did not give or pay directly or indirectly, any commission, amount, fee, or any form of consideration, pecuniary or otherwise, to any person or official, personnel or representative of the government in relation to any procurement project or activity.
10. In case advance payment was made or given, failure to perform or deliver any of the obligations and undertakings in the contract shall be sufficient grounds to constitute criminal liability for Swindling (Estafa) or the commission of fraud with unfaithfulness or abuse of confidence through misappropriating or converting any payment received by a person or entity under an obligation involving the duty to deliver certain goods or services, to the prejudice of the public and the government of the Philippines pursuant to Article 315 of Act No. 3815 s. 1930, as amended, or the Revised Penal Code.

IN WITNESS WHEREOF, I have hereunto set my hand this ___ day of ___, 20___ at _____, Philippines.

*[Insert NAME OF BIDDER OR ITS AUTHORIZED
REPRESENTATIVE]*

[Insert signatory's legal capacity]
Affiant

[Jurat]

[Format shall be based on the latest Rules on Notarial Practice]

Standard Form No: NPCSF-GOODS-08

BID LETTER

Date: _____

To: **THE PRESIDENT**
National Power Corporation
Gabriel Y. Itchon Building
Sen. Miriam P. Defensor-Santiago Blvd.
(formerly BIR Road) corner Quezon Avenue
Diliman, Quezon City, Philippines 1100

Gentlemen:

Having examined the Bidding Documents including Bid Bulletin Numbers *[insert numbers]*_____, the receipt of which is hereby duly acknowledged, we, the undersigned, offer to perform **SUPPLY, DELIVERY, INSTALLATION, TESTING AND COMMISSIONING OF HOUSEHOLD ELECTRICAL CONNECTION FOR CAGAYAN AREAS PROJECT (LuzP24Z1728Sm)** in conformity with the said Bidding Documents for the sum of *[total Bid amount in words and figures]*_____ or such other sums as may be ascertained in accordance with the Schedule of Prices attached herewith and made part of this Bid.

We undertake, if our Bid is accepted, to supply and deliver the goods and perform other services, if required within the contract duration and in accordance with the scope of the contract specified in the Schedule of Requirements and Technical Specifications.

If our Bid is accepted, we undertake to provide a performance security in the form, amounts, and within the times specified in the Bidding Documents.

We agree to abide by this Bid for the Bid Validity Period specified in Bid Documents and it shall remain binding upon us and may be accepted at any time before the expiration of that period.

Until a formal Contract is prepared and executed, this Bid, together with your written acceptance thereof and your Notice of Award, shall be binding upon us.

We understand that you are not bound to accept the Lowest Calculated Bid or any Bid you may receive.

We certify/confirm that we comply with the eligibility requirements pursuant to the Bidding Documents.

We likewise certify/confirm that the undersigned, *[for sole proprietorships, insert: as the owner and sole proprietor or authorized representative of [Name of Bidder]*_____ has the full power and authority to participate, submit the bid, and to sign and execute the ensuing contract, on the latter's behalf for the *[Name of Project]*_____ of the National Power Corporation *[for partnerships, corporations, cooperatives, or joint ventures, insert: is granted full power and authority by the [Name of Bidder]*_____ to participate, submit the bid, and to sign and execute the ensuing contract on the latter's behalf for *[Name of Project]*_____ of the National Power Corporation.

We acknowledge that failure to sign each and every page of this Bid Letter, including the attached Schedule of Requirements (Bid Price Schedule), shall be a ground for the rejection of our bid.

[name and signature of authorized signatory]

[in the capacity of]

Duly authorized to sign Bid for and on behalf of _____
[name of bidder]

Bank Guarantee Form for Advance Payment

To: **THE PRESIDENT**
National Power Corporation
Gabriel Y. Itchon Building
Sen. Miriam P. Defensor-Santiago Blvd.
(formerly BIR Road) corner Quezon Avenue
Diliman, Quezon City, Philippines 1100

[name of Contract]

Gentlemen and/or Ladies:

In accordance with the Advance Payment Provision, of the General Conditions of Contract, *[name and address of Supplier]* (hereinafter called the "Supplier") shall deposit with the PROCURING ENTITY a bank guarantee to guarantee its proper and faithful performance under the said Clause of the Contract in an amount of *[amount of guarantee in figures and words]*.

We, the *[name of the universal/commercial bank]*, as instructed by the Supplier, agree unconditionally and irrevocably to guarantee as primary obligator and not as surety merely, the payment to the PROCURING ENTITY on its first demand without whatsoever right of objection on our part and without its first claim to the Supplier, in the amount not exceeding *[amount of guarantee in figures and words]*.

We further agree that no change or addition to or other modification of the terms of the Contract to be performed thereunder or of any of the Contract documents which may be made between the PROCURING ENTITY and the Supplier, shall in any way release us from any liability under this guarantee, and we hereby waive notice of any such change, addition, or modification.

This guarantee shall remain valid and in full effect from the date the advance payment is received by the Supplier under the Contract and until the Goods are accepted by the PROCURING ENTITY.

Yours truly,

Signature and seal of the Guarantors

[name of bank or financial institution]

[address]

[date]

CERTIFICATION AS A DOMESTIC BIDDER

This is to certify that based on the records of this office, (Name of Bidder) is
duly registered with the DTI on _____.

This further certifies that the articles forming part of the product of (Name of Bidder)
which are/is (Specify) are substantially composed of
articles, materials, or supplies grown, produced or manufactured in the Philippines. (Please
encircle the applicable description/s).

This certification is issued upon the request of (Name of Person/Entity) in
connection with his intention to participate in the bidding for the (Name of Project)
of the National Power Corporation (NPC).

Given this ___ day of _____ 20__ at _____, Philippines

Name

Position

Department of Trade & Industry

SECTION IX - BID DRAWINGS

EW - ELECTRICAL WORKS

DRAWING NO.	TITLE
CAP-BDE-04.001	TYPICAL SERVICE DROP ELEVATION AND DETAILS
CAP-BDE-04.002	TYPICAL HOUSEHOLD WIRING
CAP-BDE-04.003	TYPICAL HOUSEHOLD WIRING INSTALLATION DETAILS



SECTION IX

BID DRAWINGS

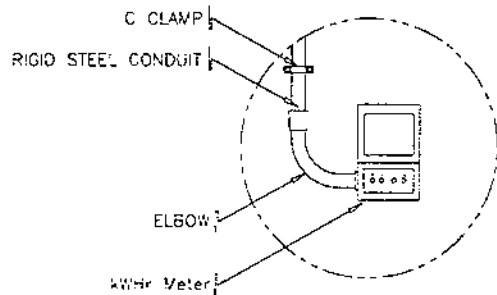

DETAIL "A"

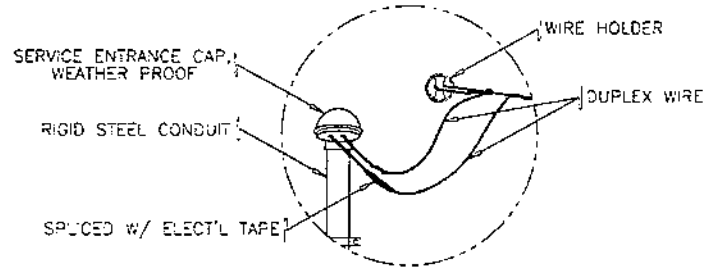

DETAIL "B"



BILL OF MATERIALS	
QTY.	DESCRIPTION
1	Digital K'wall-Hour Meter, 230V, 2wires, 10(60)A
25m	Duplex Cable #6 AWG, 8/1 stranding for service dropwire
1	Service Entrance Cap, weather proof type, 19 (3/4") dia
1	Rigid Stee. Conduit, 19 (3/4") dia x 25# (10'), w/ locknut, elbow & bushing
1	Wire Holder, universal service type no. 22
1	Tape, electrical, big
2	Tapping Connector, compression type for (#2 - #8)
10m	Wire, 8.0 mm2 TH-N/7-WN-2, 60CV

NOTES:

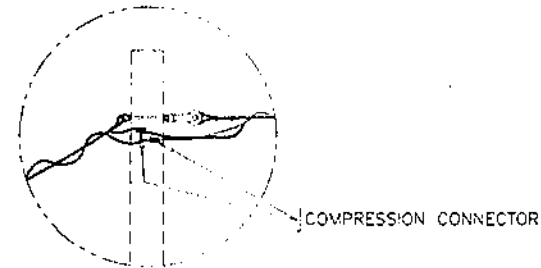
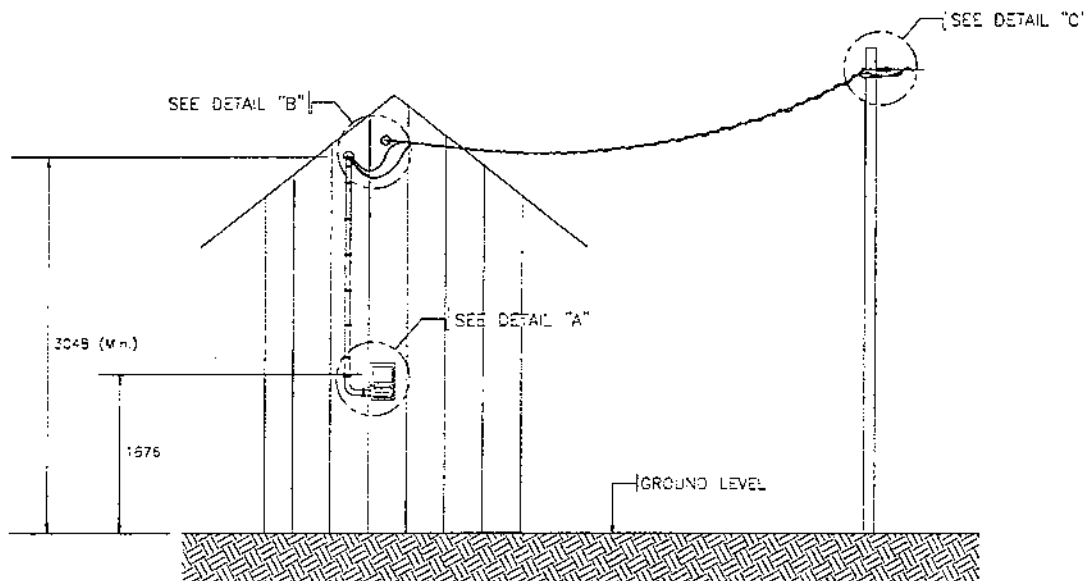
ALL DIMENSIONS AS SHOWN ARE IN MILLIMETERS UNLESS OTHERWISE INDICATED

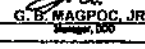

DETAIL "C"

OWNER:  NATIONAL POWER CORPORATION GABRIEL Y. LEONARDO, SEN. MANAGING DIRECTOR, SANTIAGO AVENUE (FORMERLY BIR ROAD) CORNER R. RUE FOR AVENUE, DUBAIAN 1100 QUEZON CITY, PHILIPPINES	
PROJECT: SUPPLY DELIVERY, INSTALLATION, TESTING AND COMMISSIONING OF HOUSE-HOLD CONNECTION MATERIALS FOR CAGAYAN AREAS PROJECT	
LOCATION: VARIOUS AREAS IN CAGAYAN	
TITLE: TYPICAL SERVICE DROP ELEVATION AND DETAILS	
DESIGNED BY: [] CHD DATE: []	SUBMITTED BY:  G. F. C. BARRETTO Manager, EDCO
DRAWN BY: []	REVIEWED BY:  A. S. CANDELARIA VI Manager, EDCO
CHECKED BY: []	APPROVED BY:  G. B. MAGPOC, JR. Manager, EDCO
DWG. NO. CAP-BDE-04.001	SPEC. NO. LuzP24Z1728Sm
SCALE: NTS	BID DRAWING
REV. 0	REV. 0

REV.	DATE	NATURE OF REVISION	BY	CHKD.	RECD.	APP.

NOTES:

1. DRAWING AS SHOWN IS TENTATIVE AND FOR BIDDING PURPOSES ONLY. FINAL ELECTRICAL LAYOUT AND LOCATION OF LIGHTINGS, SWITCHES AND RECEPTACLES SHALL BE DETERMINED DURING ACTUAL INSTALLATION OR AS PER END-USER DIRECTIONS.
2. WORK THIS DRAWING WITH DWG. NO. CAP-BDE-04.003.

LEGEND:

- — — — — CIRCUIT RUNNING ABOVE GROUND
- - - - - CONTROL SWITCH WIRING
- — 9WATTS COMPACT LED LAMP
- ⊕ — CONVENIENCE OUTLET, DUPLEX
- S₁ — SWITCH, 1-GANG (No. denotes fixtures to be controlled)
- — 20AT, 10KA, 240V ENCLOSED CIRCUIT BREAKER
- ⊙ — 240V, 1-PH, 2-WIRE KILOWATT-HOUR METER

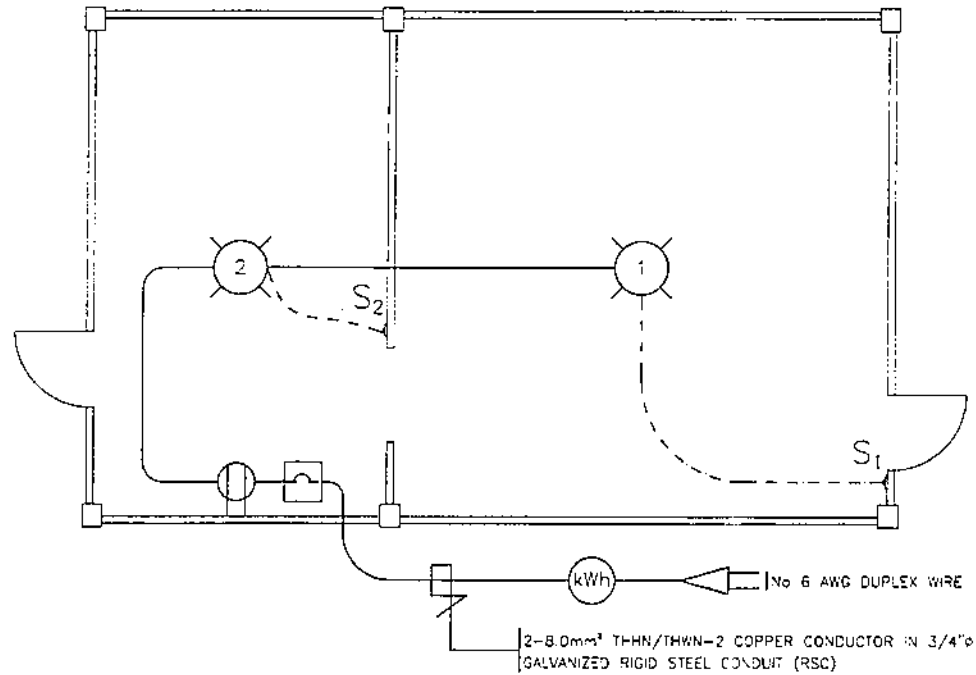

OWNER:		 NATIONAL POWER CORPORATION <small>DABOY Y. ITCHON BLDG., NEW MARIAN P. DEFENSOR-SANTIAGO AVENUE (FORMERLY BIR ROAD) CORNER QUEZON AVENUE, QUEZON CITY, PHILIPPINES</small>	
PROJECT:		SUPPLY DELIVERY, INSTALLATION, TESTING AND COMMISSIONING OF HOUSEHOLD CONNECTION MATERIALS FOR CAGAYAN AREAS PROJECT	
LOCATION:		VARIOUS AREAS IN CAGAYAN	
TITLE: TYPICAL HOUSEHOLD WIRING			
	BY	CHKD	DATE
DRAWN			
REVIEWED	PRINCIPAL ENGR./ARCHT.		SUBMITTED: G. F. BARRETTO <small>Engr., ECE</small>
CHECKED			RECOMMENDED: A. S. CANDELARIA, BE <small>Engr., ECE</small>
ELEC.			APPROVED: G. B. MAGROC, JR. <small>Engr., ECE</small>
MECH.			
DWG. NO. CAP-BDE-04.002		SPEC. NO. LUZP24Z1728SM	
REV.	DATE	NATURE OF REVISION	BY
SCALE: NTS		BID DRAWING	
			REV. 0

NOTES:

- DRAWING AS SHOWN IS TENTATIVE AND FOR BIDDING PURPOSES ONLY. ACTUAL DETAILS OF INSTALLATION SHALL BE DETERMINED AT SITE.

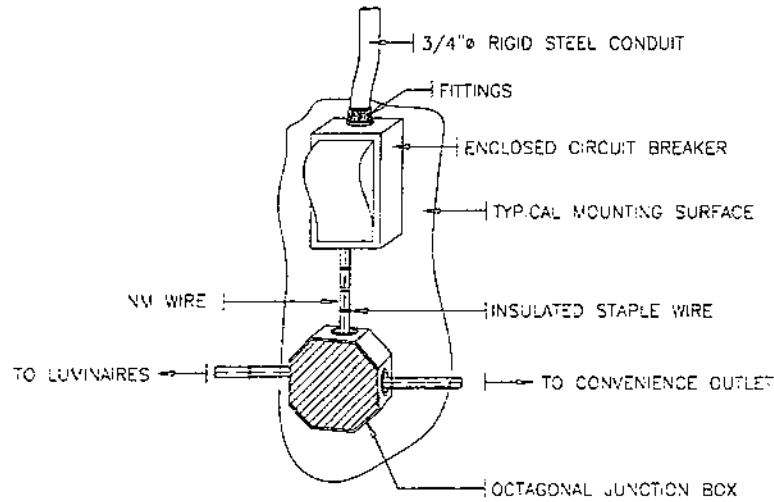

TYPICAL SERVICE ENTRANCE INSTALLATION

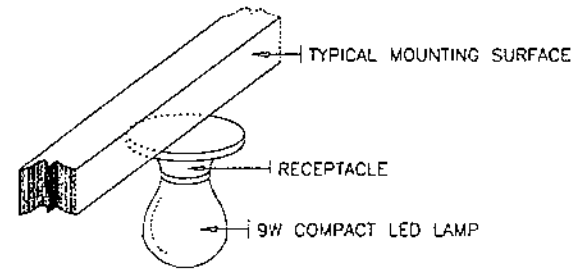

TYPICAL LIGHTING FIXTURE INSTALLATION

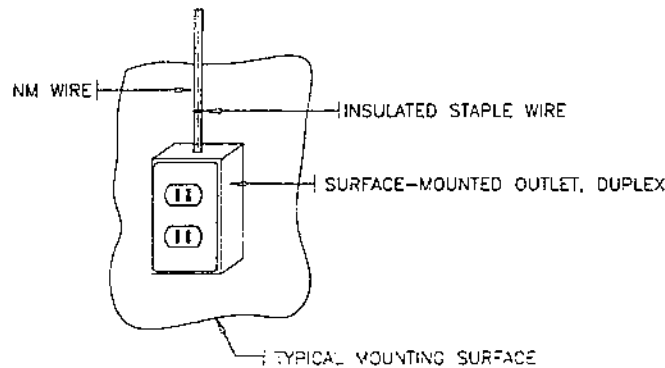

TYPICAL CONVENIENCE OUTLET INSTALLATION

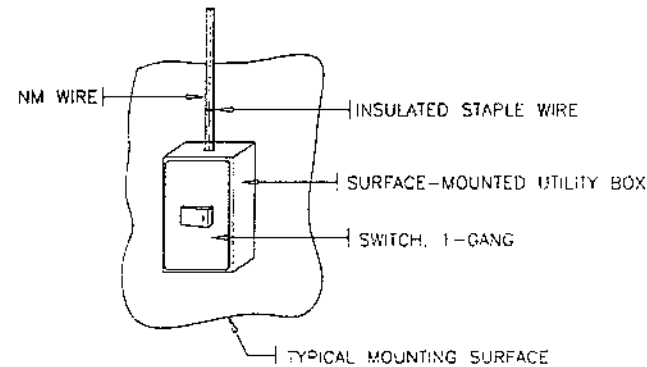

TYPICAL LIGHTING SWITCH INSTALLATION

OWNER:		 NATIONAL POWER CORPORATION <small>CARLOS Y. JOSTON BLDG., SEN. MIRAMAR P. DEFFENSOR-SANTIAGO AVENUE (FORMERLY EDSA ROAD) CORNER QUEZON AVENUE ORAMA 1100 QUEZON CITY, PHILIPPINES</small>	
PROJECT:		SUPPLY, DELIVERY, INSTALLATION, TESTING AND COMMISSIONING OF HOUSEHOLD CONNECTION MATERIALS FOR CAGAYAN AREAS PROJECT	
LOCATION:		VARIOUS AREAS IN CAGAYAN	
TITLE:		TYPICAL HOUSEHOLD WIRING INSTALLATION DETAILS	
DESIGNED	BY	CHKD	DATE
DRAWN			
REVIEWED	PRINCIPAL ELECTRICAL ENGR.		RECOMMENDED: A. S. ORONDELARIA III <small>Engr., ECE</small>
CHECKED			APPROVED: G. B. MAGPOC, JR. <small>Engr., ECE</small>
DATE			
DWG. NO. CAP-BDE-04.003		SPEC. NO. LuzP24Z1728Sm	
SCALE: NTS		BID DRAWING	
REV. DATE		NATURE OF REVISION	
BY	CHKD	REGL	APPD.
		REV. 0	